



Competition Regulations 2015-2016

Rules Governing Model Aviation
Competition in the United States

Radio Control Scale Aerobatics

Amendment Listing

Original Issue	1/1/2013	Publication of Competition Regulations
Model Aircraft Specifications	1/1/2015	4.3 addresses electronic stabilization
Pilot control of the aircraft	1/1/2015	10.3 Pilot control of the aircraft
General Criteria	1/1/2015	7.2.1 General Criteria
Round Corners	1/1/2015	7.2.2a Round Corners
Corner Angles	1/1/2015	7.2.2b Corner Angles



supporting the sport of
scale aerobatic competition

Table of Contents

SECTION I: GENERAL PRINCIPLES	7
1. Objective	7
2. General	7
3. Open Events	7
4. Model Aircraft Specifications	8
5. Scale Aerobatic Sound Limits	8
5.1. In-Flight Judging Criteria	8
6. Proof of Scale	9
7. Material and Workmanship	9
8. Competition Classes	9
9. Classification - Contestant, Season, Advancement	10
10. Official Flights	10
10.1: Official flight for known program	10
10.2: Official flight for unknown program.	11
10.3: Pilot control of the aircraft	12
11. Number of Flights	12
12. Aerobatic Airspace	12
13. Time Limits	12
14. Point System	13
15. Determining Placement	14
16. Flight Pattern	14
17. Four (4) Minute Freestyle Program	15
17.2: Judging the Four (4) Minute Free Program	17
 SECTION II: SCALE AEROBATICS OFFICIAL FLYING AND JUDGING	
GUIDE	18
1. Preface	18
1.1: Mental attitude	19
1.1.1: Bias	19
1.1.2: Self-confidence	19
1.1.3: Sense of independence	19
1.1.4: Adherence to the rules	19
1.1.5: Technical knowledge	20
2. FAI ARESTI System (Condensed)	20
3. Rules	21
4. Aerobatic Airspace	21
4.1: X-Axis and Y-Axis	21
4.2: Deadline	21
4.3: Airspace Control Score	21
5. Flight Path, Aircraft Attitude, and Wind Correction	22
5.1: Flight path	22

5.2: Attitude	23
5.3. Wind Correction.....	24
6. Grading of Figures.....	26
6.1: General principles.....	26
6.2: Beginning and ending of a figure.....	27
6.3: Zero.....	28
c.1: A Corrective Maneuver	28
d: Break in the sequence.....	29
Resumption of scored flight.....	29
7. Basic Components of Aerobatics	30
7.1: Lines	30
7.2: Loops and part-loops.....	32
7.2.1: General Criteria	32
7.2.2: Matching Radii.....	33
8. FAI “ARESTI Aerobic Catalogue (Condensed)” Families	34
8.1: Family 1: Lines and Angles.....	34
8.2: Family 2: Turns and Rolling Turns	34
8.2.1: Turns.....	34
8.2.2: Rolling Turns.....	35
8.3. Family 3: Combinations of Lines.....	37
8.5: Family 5.2-5.4: Stall Turns	37
8.6: Family 6.2: Two Line Tail Slides	40
8.7: Family 7: Loops and Eights	41
8.7.1: General Principles.....	41
8.7.2: Family 7.2: Half Loops	42
8.7.3: Family 7.3: Three-Quarter Loops.....	43
8.7.4: Family 7.4: Whole Loops.....	44
8.7.4.a: Round Loops (7.4.1 – 7.4.2).....	44
8.7.4.b: Family 7.4.3- 7.4.6: Square, Diamond and Octagon Loops	45
8.7.4.c: Family 7.4.7-7.4.14: Reversing Whole Loops.....	46
8.7.5a. Family 7.5.1-7.5.8: Horizontal “S”s	46
8.7.5b. Family 7.5.9-7.5.10: Vertical “S”s.....	47
8.7.8a: Family 7.8.1 - 7.8.8: Horizontal Eights.....	47
8.7.8b: Family 7.8.9 - 7.8.16: Horizontal Super “8”s.....	48
8.7.8c: Family 7.8.17 – 7.8.22: Vertical “8”s.....	48
8.8: Family 8: Combination of Lines, Loops, and Rolls.....	49
8.8.1 – General Principles	49
8.8.4.1: Family 8.4.1 - 8.4.28: Humpty Bumps and Diagonal Humpty Bumps	50
8.8.5: Family 8.5.1-8.5.24: Half Cubans and Vertical 5/8ths Loops	50
8.8.6: Family 8.6: “P” Loops and Reversing “P” Loops.....	51
8.8.7: Family 8.7: 7/8 th s Loops	51
8.8.8: Family 8.8: Double Humpty Bumps	52
8.8.10: Family 8.10: Reversing 1 ¼ Loops	52
8.9: Family 9: Rotational Elements. Rolls.....	53
8.9.1: Family 9.1: Rolls.....	54
8.9.2: Family 9.2 - 9.8: Point Rolls	55
8.9.3: Family 9.9: Snap Rolls (“Flick Rolls”)	55
8.9.5: Family 9.11 - 9.12: Spins.....	57

Note: Vertical lines next to type and or graphic indicate a change has been made.

RADIO CONTROL SCALE AEROBATICS

SECTION I: GENERAL PRINCIPLES

1. Objective: Inspired by full-scale aerobatics, we strive to fly scale aerobatic model aircraft in a competitive and realistic manner that is challenging for the contestants as well as interesting for spectators.

2. General: All AMA regulations and FCC regulations covering the RC flier, airplane and equipment, shall be applicable to this event.

2.1: Consideration of safety for spectators, contest personnel, and other contestants is of the utmost importance in this event. Any unsportsmanlike conduct or hazardous flying over a controlled spectator area will be cause for immediate disqualification of that flight. Further infractions will result in the removal of that pilot from the contest.

3. Open Events:

3.1: The events accommodate aerobatic monoplanes and biplanes which are replicas of types known to have competed in International Aerobatic Club (IAC) competition, or replicas of types known to be capable of aerobatic competition within the airspace known as the “Box.”

3.2: All classes except Basic require that the pilot must meet the requirements defined in Rule 3.1. The Basic Class is open to all competitors with a monoplane or biplane aircraft. There is no minimum size requirement for any class. Contest Directors may make an exception for a model of a full scale aircraft that was built for IAC competition, but has not yet competed. Proof of the latter is the responsibility of the contestant.

3.3: The known sequences will be developed, annually, by the IMAC Sequence Committee, in accordance with the current FAI “ARESTI Aerobatic Catalogue.” The IMAC Board of Directors must approve all know sequences for use in IMAC competition.

3.4: The unknown sequences will be drawn from the catalog of Legal Unknown Figures for each class. The catalog of legal Unknown Figures is located on the ARESTI Website.

3.5: Difficulty of “K” factors for known and unknown sequences will be derived from the current FAI “ARESTI Aerobatic Catalogue.”

4. Model Aircraft Specifications:

4.1: Only one (1) propeller per aircraft shall be allowed. Internal combustion reciprocating engines and electric motors shall be allowed. If the aircraft is utilizing an internal combustion engine, only one (1) engine shall be allowed. If the aircraft is utilizing electric motors, more than one (1) electric motor may be used. **4.2:** The model shall comply with all AMA Safety Codes.

4.3: There shall be no airborne devices fitted to the aircraft which place the aircraft under less than total control by the pilot. These devices will include, but are not limited to, gyros, automatic pilots, electronic stabilization, and timing devices. Non-airborne aids such as transmitter based functions are permissible.

Pilots found to be using prohibited devices will be disqualified from the contest.

4.4: The Builder-of-the-Model (BOM) rule shall not apply.

5. Scale Aerobatic Sound Limits (Figure 1 Intentionally Removed From the F&G

5.1. In-Flight Judging Criteria, Known and Unknown Sequences.

Judges will evaluate each individual sequence flown in its entirety for overall sound presentation. Each judged Known and Unknown sequence, shall have one “figure” added to the end of the score sheet after individually judged maneuvers. This figure shall be known as the Sound Score. The Sound Score will have a K value dependent on the class flown.

Individual class K values are:

- Unlimited 15 K
- Advanced 12K
- Intermediate 9K
- Sportsman 6K
- Basic 3K.

The sound presentation will be scored on a scale of 10 to 0 with 10 denoting “Very Quiet,” and 0 denoting “Very noisy.” Whole points will be used for scoring. This sound score will then be multiplied by the K value for the individual class and included in the total flight score for the sequence. Note that each judge’s score is independent of the other(s) and no conferencing on the sound score is required.

If a pilot receives a sound score of three (3) or less for the same sequence from two or more judges, the pilot will be notified of the problem and will be requested by the Contest Director to adjust or modify the aircraft in order to reduce the sound level prior to the next round. If that pilot, after notification, again receives a sound score of three (3) or less for the same sequence from two or more judges, that pilot will be disqualified from further competition at that contest.

6. Proof of Scale:

6.1: To prove that the model resembles a particular aircraft some proof of scale is required.

6.2: Proof of scale is the responsibility of the contestant.

6.3: The general outlines of the model shall approximate the full size outlines of the subject aircraft. Exact scale is not required. The model shall be judged for likeness at a distance of approximately 10 feet.

6.4: If the contestant presents no proof of scale material with the model, and the CD can determine that the aircraft is a replica of a full-size aircraft, then the contestant will be allowed to have his/her entry considered.

6.5: Scale shall be determined by the wingspan. A change in wingspan will become a change in overall Scale. Fuselage width, height and aircraft planform or any other variations shall not exceed 10% of scale, with the exception of airfoils and size/shape of control surface within the scale outline rule.

6.6: A realistic three-dimensional human pilot and viewable instrument panel shall be appropriately installed in all Scale Aerobatic aircraft. (A one [1%] flight score penalty will be assessed for noncompliance.)

7. Material and Workmanship: Workmanship must be of satisfactory standards. The Contest Directors are empowered to refuse permission to fly, or to disqualify any aircraft which, in their opinion, is not up to reasonably safe standards in materials, workmanship, or radio installation.

8. Competition Classes:

8.1: The event shall be divided into five (5) classes, in order of increasing difficulty. The classes are Basic (411), Sportsman (412), Intermediate (415), Advanced (413), and Unlimited (414).

8.2: An Optional Four (4) Minute Freestyle may also be offered. A pilot must compete in one of the above classes to be eligible for the freestyle event.

8.3: Contest Directors and/or the sponsors of a sanctioned meet shall determine which of the classes and events will be flown. Such information must accompany all advance notices pertaining to the contest, including any planned deviation from standard rules, at least 30 days prior to the date of the contest.

9. Classification - Contestant, Season, Advancement:

9.1: A contestant may enter any one competition class at their own option. Once having flown a contest in a class, a contestant may not compete in a lower class without written permission from their regional director.

9.2: In the USA the new contest season begins on January 1 of each year. On or before that time, the new Known sequences for all classes will be approved by the IMAC Board of Directors and made available to the IMAC membership on the IMAC website.

9.3: A contestant in Basic through Advanced classes will be required to move to the next higher class at the beginning of the next calendar year if the contestant wins five (5) or more contests in the current year provided that in each winning contest the contestant flew against at least four (4) other competitors who made official flights. If any of the contestant's winning contests had fewer than four (4) other competitors that made official flights, that contest will not be counted in the total of winning contests used to force advancement in class.

10. Official Flights:

10.1: Official flight for known program.

10.1.1: An official flight (round) for the known program is defined as two (2) sequences. When time constraints prevent two (2) sequences from being flown, a round may consist of one (1) sequence. Contestants shall have one attempt per sequence to complete the sequence. An attempt begins when the pilot or caller makes a vocal declaration such as "In the box", "Entering", or a similar statement indicating when the pilot is starting the sequence. A vocal signal is mandatory to initiate the attempt. If a vocal declaration is not made the pilot becomes subject to the other standard constraints stipulated in these rules, e.g., time limit for entering, no aerobatics before entering, etc. Once the attempt is made by means of the vocal declaration, judging will begin as soon as the aircraft departs from the wings-level horizontal entry line and enters the first maneuver of the sequence. The horizontal entry line to the first maneuver of a sequence is not judged.

10.1.2: If a Known sequence in progress is determined by the judges to have been interrupted by a circumstance beyond the control of the contestant, the contestant may resume the sequence with the maneuver in progress at the time of the interruption. This maneuver will be scored. Note that a mid-air collision is considered to be "beyond the control of the contestant." If a mid-air occurs, each pilot, if still flying, must land and pass a safety inspection by the CD before continuing with that aircraft. The pilot also has the option of continuing with a different plane. After the mid-air, each pilot involved will declare his/her intention to complete the round or not. If

the contestant chooses to continue, they will be positioned last in the round and be subject to whatever time constraints may be in force at the contest. In this case, no penalty will be imposed for repositioning to the end of the round rotation. When the contestant is again airborne they will resume the round with the figure prior to that in which the interruption occurred. This figure will not be judged. Judging will resume after the completion of said prior figure. If the contestant chooses not to continue the round, they will receive zeros for all maneuvers not yet scored at the time of the mid-air.

10.1.3: If a Known sequence in progress cannot be completed due to mechanical problems with the aircraft (including but not limited to engine failure, radio malfunction, etc...) the contestant will receive zeros for each un-scored maneuver in that sequence. If the second sequence is yet to be flown and the aircraft can be made ready to fly the contestant may attempt the second sequence. In such cases, the contestant will be positioned last in the round and be subject to whatever time constraints may be in force at the contest. When the contestant is again airborne they will fly the second sequence. In this case, no penalty will be imposed for repositioning to the end of the round rotation.

10.1.4: An official flight (round) is two (2) sequences and the contestant is expected to be able to fly both sequences without refueling between sequences. If the second sequence cannot be completed the contestants will receive zero (0) for each un-scored maneuver in that sequence. The only exception is if Rule 10.1.2 is in effect.

10.2: Official flight for unknown program.

10.2.1: An official flight (round) for the unknown program is defined as one (1) sequence. Contestants shall have one attempt to complete the sequence. An attempt begins when the pilot or caller makes a vocal declaration such as "In the box", "Entering", or a similar statement indicating when the pilot is starting the sequence. A vocal signal is mandatory to initiate the attempt. If a vocal declaration is not made the pilot becomes subject to the other standard constraints stipulated in these rules, e.g., time limit for entering, no aerobatics before entering, etc.

Once the attempt is made by means of the vocal declaration, judging will begin as soon as the aircraft departs from the wings-level horizontal entry line and enters the first maneuver of the sequence. The horizontal entry line to the first maneuver of a sequence is not judged.

10.2.2: If an Unknown sequence in progress is determined by the judges to have been interrupted by a circumstance beyond the control of the contestant, the contestant may resume the sequence with the figure prior to the interruption. This figure will not be judged. Judging will resume after completion of said prior figure. Note that a mid-air collision is considered to be "beyond the control of the contestant". If a mid-air occurs, each pilot, if

still flying, must land and pass a safety inspection by the CD before continuing. The pilot has the option of continuing with a different plane.

After the mid-air, each pilot involved will declare his/her intention to complete the round or not. If the contestant chooses to continue, they will be positioned last in the round and be subject to whatever time constraints may be in force at the contest. In this case, no penalty will be imposed for repositioning to the end of the round rotation. When the contestant is again airborne they will resume the round with the figure prior to that in which the interruption occurred. This figure will not be judged. Judging will resume after the completion of said prior figure. If the contestant chooses not to continue the round, they will receive zeros for all maneuvers not yet scored at the time of the mid-air.

10.2.3: If an unknown sequence in progress cannot be completed due to mechanical problems with the aircraft (including but not limited to, engine failure, low fuel, radio malfunctions, etc.), the contestant will receive zeros (0) for each un-scored maneuver in that sequence.

10.3: Pilot control of the aircraft. Once the pilot announces an attempt until the pilot completes the sequence, (known, unknown, or freestyle) only the pilot may operate the transmitter which is controlling the aircraft. Any assistance of any kind provided by another person to operate the transmitter (e.g., changing switches, programming modes, etc.) will result in the pilot receiving a zero for the sequence or Freestyle in progress when the assistance was provided. This rule applies only from entering the sequence until the sequence is complete. This rule does not apply to takeoff, landing, or flight between sequences.

11. Number of Flights: There shall be no limit on the number of flights (other than that imposed by time available).

12. Aerobatic Airspace: Refer to Section II, Paragraph 4.

13. Time Limits:

13.1: The contestant has two (2) minutes to start his/her engine and become airborne. If after two (2) minutes the contestant is unable to start the engine, they will move to the end of the round rotation. If the contestant fails to start a second time, they shall receive zero for the round.

13.2: The contestant has one (1) minute from the time the wheels leave the ground during takeoff to enter the aerobatic airspace.

13.3: There shall be no time limit while in the aerobatic airspace.

13.4: The contestant has two (2) minutes between leaving the aerobatic airspace and touchdown for landing, unless required to hold upon command from the appropriate official.

13.5: Prior to entering the aerobatic airspace, between sequences, and prior to landing, pilots shall only be allowed to perform the following trim and positioning maneuvers:

- Turns;
- Half Cubans with only a single ½ roll on the 45 down line;
- Reverse Half Cubans with only a single ½ roll on the 45 up line;
- The ½ roll is optional based on aircraft positioning required to enter the aerobatic airspace;
- Half loops up or down (Immelmann or Split S) with only one half roll on entry or exit;
- Single half roll to inverted immediately prior to entering the aerobatic airspace for the case in which an inverted entry to the first maneuver is required;
- Single half roll to upright immediately after exiting the aerobatic airspace for the case in which an inverted exit from the last maneuver is required;
- A vertical up or down line with a simple push/pull for entry and exit. A single 1/2 roll is allowed on this vertical line only if required to orient the aircraft properly for entry to the first maneuver.

Exceptions to this limitation may only be directed by the CD or line boss in the normal course of safely managing the airspace. Pilots will follow such directions and no penalty will apply.

Turnaround maneuvers may not be performed at low altitude or directly in front of the judges. No other aerobatic maneuvers are allowed immediately following the airplane breaking ground except for the Four Minute Freestyle. Any infraction shall result in a penalty of zeroing the round.

The intent here is to prevent anything that may be viewed as “practice” and hence give one competitor an advantage over another. Therefore, snaps, spins, point rolls, Humpty’s, Tailslides, etc, etc.... may never be executed after breaking ground and before entering the sequence, between sequences or after completing the sequence(s) and prior to landing.

14. Point System:

14.1: All classes shall have the scheduled maneuvers scored on a scale of 10 to 0. Half (0.5) points may be used in judging. Points are deducted for imperfections as per the Scale Aerobatics Official Flying and Judging Guide (Section II of this document).

14.2: Degree of difficulty factor (K-factor) values shall be assigned to individual maneuvers based upon the current FAI catalog of maneuvers, with modifications as required by the International Miniature Aerobatic Club (IMAC). When calculating contestant scores, each individual maneuver score

shall be multiplied by its K-factor. The flight score shall be the result of summing the “K-factored” (maneuver score multiplied by K-factor) scores.

15. Determining Placement:

15.1: Sequence scoring.

a: Scoring –The Official IMAC Scale Aerobatics Contest Guide shall be used to determine the number of sequences to be scored (drop schedule) and the weight of the unknown(s) based on contest category (2 day, multi-day, regional, etc). Refer to Appendix A of the Official IMAC Scale Aerobatics Contest Guide for the drop schedule for known and unknown sequence flights.

b: Unknowns – Each unknown sequence shall be flown once. The Official IMAC Contest Guide shall be used to determine how the known scores and unknown scores are combined based on contest category.

c: Combined Scores – The highest combined scores will determine the winner.

d: Normalization – All sequences will be normalized to 1000 as outlined in Rule 15.4.

15.2: In the case of ties, the best non-scored sequence of the contestant shall be used to determine the winner.

15.3: The same set of judges shall judge each round. Judges may be rotated between rounds.

15.4: Each sequence shall be normalized to a standard 1000 points. The pilot with the highest raw score receives 1000 points for the sequence. Each pilot thereafter shall have their raw score divided by the high raw score giving a percentage of that high raw score, which is then multiplied by 1000 to get the normalized score. Scores shall be rounded to two (2) places of decimal accuracy. For example: Contestant A wins the sequence with a raw score of 4850 points. Contest B is second with 4766.5 points. Contestant A receives 1000 points for the sequence. Contestant B’s score is 982.78 points (4766.5 divided by 4850 = 0.982783 * 1000 for 982.783, which rounded to two (2) places of decimal accuracy for a final score of 982.78).

16. Flight Pattern:

16.1: A contest shall include one (1) or more rounds of Known sequences and may include one (1) or more Unknown sequences. Any given unknown sequence can only be flown once per contest.

16.2: Compulsory Known Maneuver Sequences are defined by rule 3.3.

16.3: Optional Unknown Maneuver Sequences shall include separate Sportsman, Intermediate, Advanced, and Unlimited sequences, each consisting of up to 15 maneuvers.

a: Unknowns shall be distributed the day of the contest or the night before to allow pilots to mentally fly and visualize them. If a contestant is found to have practiced the Unknowns with a flying model or on a computerized flight simulator, that contestant will be disqualified from the entire contest.

b: Flight order for the Unknowns should be established by random drawing.

16.4: The contestant must fly his entire flight according to the established flight schedule for his particular class and in the sequence listed. Maneuvers that are executed out of sequence, or not executed as required by the sequence, will be zeroed. Remaining maneuvers that are flown in their appropriate area and in the appropriate order following the zeroed maneuver will be scored.

16.5: Takeoff and landing are not to be considered judged maneuvers. It is not necessary for the judges to see the aircraft take off or land. The aircraft may be carried to the takeoff point, and carried from the landing area, if so desired.

17. Four (4) Minute Freestyle Program:

17.1: The four (4) Minute Freestyle Program is a “Show Time” separate event. It is an unrestricted, individually created sequence in which “Anything Safe Goes!” To be eligible to participate and compete in this event, the competitor must also compete in one of the five IMAC categories of precision sequence flying at the same event. It should have separate awards when offered. It is graded on the following criteria:

A: Technical Merit {90 K}

a.1: Complete Use of the Flight Envelope Utilizing the Exploitation of Aerodynamic and Gyroscopic Forces (20 K). The pilot is expected to make full use of the flight envelope of the aircraft. This means flying the full range of airspeeds and accelerations permitted.

Program time should be divided between high and low speeds, high and low G maneuvers, and both positively and negatively G loaded flight segments. The flight should include the demonstration of controlled flight beyond the stall boundary by use of autorotation or other high angle of attack maneuvers. The judge will deduct points if any of these areas are noticeably underutilized.

The pilot is expected to show movement of the aircraft about all axes using both conventional aerodynamic controls and propeller-generated gyroscopic forces. Higher grades will be given to pilots able to make use of all these effects through a wide range of aircraft attitudes and flight paths. Repeated use of any such forces in the same or similar attitudes should result in lower scores.

a.2: Execution of Individual Maneuvers (40 K). It should be clear that the maneuvers flown were, in fact, intended and fully under the pilot's control. Higher marks will be given for this objective when individual maneuver elements are started and finished on obviously precise headings and in well defined attitudes.

When, for example, gyroscopic maneuvers are allowed to decay into imprecise, poorly defined autorotation, marks should be deducted for poor execution. Marks should also be deducted if it appears that the pilot has relinquished control the aircraft at any time.

a.3: Wide Variety of Figures Flown on Different Axes and Flight Paths (30 K). Many different figures should be completed in the time available. These should include maneuver elements of many different kinds and should use many different flight paths and axes.

Lower marks should be given to a pilot who used only one or two principal axes of flight. However, the use additional axes within the performance zone must be clear and precise, not giving the appearance of being used by chance.

Marks should also be deducted if any particular maneuver element is overused or continues for an excessive period of time. For example, higher marks would be given in the event of a two-turn flat spin followed by something else, than to a multi-turn spin that simply took up more time.

B: Artistic Impression {90 K}

b.1: Pleasing and Continuous Flow of Figures with Contrasting periods of Dynamic and Graceful Maneuvers (50 K). In a precisely flown sequence, the completion of a figure will be well described when movement about an axis ceases and a particular attitude is briefly held. The start of the next figure or maneuver should then begin without any prolonged period of inactivity caused by the need to reposition the aircraft or reorient the pilot. Marks will be deducted for any obvious period of level flight, or inactivity, required between figures.

In a musical symphony, the listener's mood may be changed by contrasting fast and slow movements. Similarly, in a 4-minute Free Program, the judge should be treated to a flight that causes different reactions. While some maneuvers involve very high speeds, sudden attitude changes and rapid rotations, others involve slower speeds or more gentle transitions. Higher marks will be given to a pilot to a pilot to find time in his program for showing such

differences of mood and pace. Marks should be deducted in this category for a flight that shows no such distinctions.

Higher marks should be given for choreography with the music to enhance the flight, and the flight choreographed to enhance and present visual impressions where both the music and aircraft are flowing together with each other and acting as a unified entity to display a harmonious presentation.

b.2: Presentation of Individual and Combinations of Figures in Their Best Orientation and Optimal Position (40 K). Figures can give different impressions when seen from different viewpoints. For example, a climbing inverted flat spin looks most impressive when the top surface of the aircraft can be seen. A loop flown in a plane inclined at 45 degrees to the vertical is best appreciated when it is flown on the Y-axis. Marks should therefore be deducted if the judge is not shown a figure in its best orientation.

Each figure has an optimum from which it is best viewed. For example, a loop flown overhead does not give the same pleasing geometry as one flown further distant. Similarly, a figure flown near the upper height limit will cause discomfort when flown at the near edge of the performance zone; a low-level horizontal figure is better seen from close by than far away. Higher marks will therefore be given when individual figures are optimally placed, while judges should deduct marks when it appears that a figure is not well placed or positioned.

C: Positioning {20 K}

c.1: Symmetry of the Presentation Utilizing the Performance Zone to Maximize the Audience and Judges Perception, Reception, and Viewing of the Program (20 K). Highest marks will be given when the sequence as a whole is balanced evenly to the left and right of the judges; direct line of vision towards the center of the performance zone. Marks should be deducted if, by design or by the influence of the wind, a pilot's program is noticeable biased to left or right.

The greater the degree of symmetrical, it may also be spread too far to either side, so that some maneuver elements are flown outside the performance zone, thus making them difficult to see and interpret. Figures may also be flown on the direct line of vision but very distant. Any part of the flight that is flown at such distances should be penalized for each excursion. The entire program should be positioned so as to maximize both the audience and judges' perception and reception of the flight as a whole.

17.2: Judging the Four (4) Minute Free Program.

a: Any number of judges can be utilized. As more judges that are used, the overall score average will be less influenced by a single judge. It is recommended that seven (7) be used. For final score tabulation it is recommended that the high and low score per judging criteria category be

discarded, and the remaining scores by multiplied by their K factors and added together to obtain the final score.

b: Each criteria will be judged from ten (10) to zero (0) in 0.1 increments, i.e., 8.7, 7.9, 9.8, etc.

c: If the pilot lands any time prior to 3 minutes 30 seconds (three and one-half minutes) the judges score is “prorated.” Example: the pilot lands at the three (3) minute time. The judges will score the contestant as though he flew four minutes. The score room will tabulate the scores normally and the pilot will receive three-fourths (75%) of the judges score for his final score. If the pilot lands any time after three and one-half minutes there is no penalty.

The judges will stop scoring when the timer announces “Time” at the four minute mark. Another Example: If the pilot lands at the two minute mark, he will receive 50% of the judges’ score.

d: Specific circumstances that will Disqualify (DQ) the competitor’s flight.

d.1: If the plane crashes, it is a Disqualification (DQ).

d.2: If the plane goes behind the deadline, it is a DQ.

d.3: If the pilot performs dangerous or unsafe maneuvers or high energy maneuvers directed at the judges or spectators, it is a DQ. (As determined by a majority of the judges and/or the CD).

SECTION II: SCALE AEROBATICS OFFICIAL FLYING AND JUDGING GUIDE

The current Scale Aerobatics Contest Director’s Guide is available from the International Miniature Aerobatics Club (IMAC) secretary, or may be downloaded from the IMAC Web site: <http://www.mini-iac.com>

1. Preface: The purpose of this Scale Aerobatics Flying and Judging Guide is to provide an accurate description of each type of maneuver used in competition and to provide a reference for use in developing a uniformly high standard of judging in all AMA sanctioned contests. Study of this guide by the competitor will help him or her learn exactly what is expected, while study by the judges will help them decide precisely how well the competitor meets these expectations.

Flying and judging are very similar in nature; this is why contestant judging is generally promoted. Nevertheless, there are some key differences between judges and pilots, mostly related to Mental Attitude and Technical

Knowledge. Reference to any gender in this document shall include both male and female.

1.1: Mental attitude. Mental attitude by itself can be divided into four (5) sub-categories:

1.1.1: Bias. Bias can either be conscious or unconscious. The conscious bias is fortunately rare, and would be for instance when a judge deliberately awards a score lower or higher than the competitor deserves. The word for that action is cheating and it shall not be tolerated. Conscious bias can also occur because a friendship or regional relationship with the competitor. Most problems with bias are of the unconscious or unintentional type since they are more prevalent. A good example would be the ‘halo’ or recognition for a champion or well-known flier who might unintentionally be awarded extra points based on recognition alone. This can work against an unknown flier having a great day. This type of bias can also work against the champion flier, just because the judge unconsciously might want to see a new face in the winner’s circle. Another example might be bias towards a certain type of airplane like mono versus biplane, or bias towards a style of flying.

For instance, a pilot cuts crisp corners on square maneuvers versus a flier with a more graceful style. Sometimes we even see an equipment bias where a judge may unknowingly try to support a previous personal opinion regarding a certain brand of radio, certain type of engine, or size of aircraft. These unconscious biases are easily understood as we all have personal preferences. Nevertheless, the judge must try hard to base his or her score solely on the quality of the flight, and nothing more.

1.1.2: Self-confidence. The self-confidence factor is based on knowledge instead of arrogance or ego. A judge with self-confidence can score a pilot fairly, whether he is a World Champion or not. A judge with self-confidence will not be uncomfortable in giving a wide range of scores in a single sequence. Scores as low as 2 or 4, or as high as 9 or 10 will not be uncommon.

1.1.3: Sense of independence. A judge doesn’t operate in a glass cage but shares the flightline with another judge and scribes. The judge cannot allow himself or herself to be influenced by more dominant or experienced personalities sitting nearby. Judging is an independent exercise and caution should be exercised not to influence or be influenced by others on the flightline. If scribes are used, scores should be communicated using a low tone voice so that the other judge and the pilot cannot hear and be influenced by it.

1.1.4: Adherence to the rules. Adherence to the rules is probably the most significant of all the elements required to make a good judge. A good judge has developed a sense of fair playing and knows that a good contest is one in which everyone plays by the same rules. Anyone sitting in a judging chair must adhere to the rules existing at that time or disqualify him or herself.

1.1.5: Technical knowledge. Technical knowledge employs the use of an organized system of downgrading as well as the need to be consistent and accurate. The downgrading or deficit grading system assumes that the contestant is going to fly a perfect maneuver that starts with a 10, and then downgrades it based on the mistakes observed as they occur, rather than falling into the trap of scoring on overall impression. It should be assumed by a judge that a contestant is going to fly a well-formed maneuver, so he should start with the grade of 10. As he watches the maneuver, he then begins to find fault with what he sees and starts downgrading as it progresses. This system is preferable to waiting until the maneuver is finished, and tries to assign a grade on overall impression. The latter can be erratic and inconsistent, and also confines grading into a too narrow range. However, as a final check, the score should be consistent with the figure's overall quality.

Every judge should strive for a high degree of consistency and accuracy. The most important aspect of consistent judging is for each judge to establish his or her standard and then maintain that standard throughout the contest.

2. FAI ARESTI System (Condensed): Scale Aerobatics sequences are based on a catalog of maneuvers adopted by the FAI (Fédération Aéronautique Internationale), from the “ARESTI Aerobatic Catalogue (Condensed)” for full-scale aircraft aerobatics. The catalog consists of the following nine (9) families of figures:

- i. Family 1 – Lines and Angles
- ii. Family 2 – Turns and Rolling Turns
- iii. Family 3 – Combinations of Lines
- iv. Family 4 – (Not in Use)
- v. Family 5 – Stall Turns
- vi. Family 6 – Tail Slides
- vii. Family 7 – Loops and Eights
- viii. Family 8 – Combinations of lines, Angles, and Loops
- ix. Family 9 – Rolls and Spins

It is beyond the scope of this Flying and Judging Guide to explain in detail the structure of the ARESTI catalog, and how to read the ARESTI drawing language used. A good judge (as well as a pilot) must become very familiar with the above and should be able to quickly understand the maneuver simply by looking at the ARESTI drawing. The complete catalog of figures is available directly from the ARESTI Web site at (<http://www.arestisystem.com>). Judges and pilots are strongly encouraged to download this document for personal reference.

3. Rules: Scale Aerobatics has several rules that differ from either Full Scale Aerobatics (IAC) or AMA RC Aerobatics (AMA Pattern). Because the judging pool used in Scale Aerobatics contests sometimes comes from both or either of those two groups, it is useful to go through the major differences:

Rules	Scale Aerobatics	IAC	Pattern
Downgrade one (1) point for each deviation of:	10 degrees (½ point for 5°)	5 degrees	15 degrees
Judging criteria:	Flight path	Aircraft attitude	Flight path
Number of judges	2 minimum	5 standard 3 minimum	2 minimum

4. Aerobic Airspace:

4.1: X-Axis and Y-Axis

The X-Axis is the main axis of flight, parallel to the flight line. The Y-Axis is perpendicular to the X-Axis (flight line).

4.2: Deadline.

The “Deadline” is located 100 feet (30.5 meters) in front of the contestant. This line delimits the “no-fly” zone for safety reasons and the aircraft must at all times remain on the side of the deadline away from the contestant, pits and spectators. The judges shall zero (0) any maneuver where the aircraft completely or partially crosses the deadline. For repeated deadline violations by a contestant during a flight, the CD may ground the flight in progress and zero the round. If a contestant repeatedly violates the deadline, the CD may disqualify the contestant from further competition at the event.

If there is no natural barrier or demarcation at or beyond 100' that can be used to clearly mark the deadline, the CD must set up clearly visible markers at the deadline distance for the judges to use in enforcing deadline observance.

4.3: Airspace Control Score

Judges will evaluate each individual sequence flown, in its entirety, for overall airspace control. Each judged Known and Unknown sequence, shall have one “figure” added to the end of the score sheet, after individually judged maneuvers. This figure shall be known as the *Airspace Control Score* and will be assigned by each judge. The Airspace Control Score will have a K value dependent on the class flown. This score will then be multiplied by the K Value for the individual class.

The following standard will be used for assessing the pilot's performance in maintaining control and awareness of the aerobatic airspace and placing figures in the airspace in a manner that allow the figures to be optimally judged.

The highest standard for Airspace Control will be the pilot that exhibits a significant ability to control the location of the aircraft inside the airspace, relative to the judges, which results in a tight footprint and has the aircraft such that it can be optimally judged at all times. The pilot that exhibits excellent airspace control should receive a ten (10).

The lowest standard for Airspace Control will be the pilot that exhibits a poor ability to control the location of the aircraft inside the airspace, relative to the judges, which results in an excessively large footprint and has the aircraft consistently so far away as to be difficult to properly judge. The pilot that exhibits very poor airspace control should receive a zero (0). Pilots exhibiting airspace control within the range of these two standards will be graded with a range of possible scores from ten (10) to zero (0) in whole point increments.

The K factors for the Airspace Control Score are:

- Basic = 3K
- Sportsman = 6K
- Intermediate = 9K
- Advanced = 12K
- Unlimited = 15K

5. Flight Path, Aircraft Attitude, and Wind Correction:

Scale Aerobatics requires all maneuvers within the sequence to be wind corrected. See Rule 5.3.

Judges should evaluate any maneuver focusing primarily on the aircraft flight path, but at the same time, also downgrade for any variation of the aircraft attitude that is not directly related to maintaining a correct flight path.

5.1: Flight path. Think of the aircraft condensed into a single dot and watch the path this dot takes through the sky. This is the flight path, or track, or the aircraft's center of gravity. Judging the flight path consists of comparing the observed path with fixed references such as the horizon, or the X and Y-axis of the aerobatic airspace.

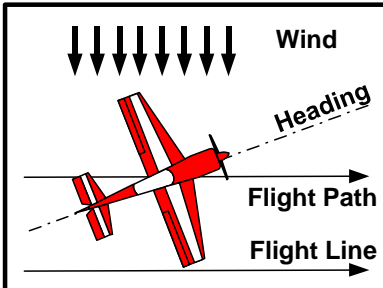

Fig. 2

Cross winds will force the aircraft to 'crab' or change its attitude in order to maintain a flight path parallel to the flight line.

5.2: Attitude. The aircraft attitude is defined as the position of the aircraft in the sky, and is characterized by the variations it has on the yaw, pitch, and roll axis. In a “no-wind” and normal speed condition, the aircraft’s attitude (its heading) will generally point in the same direction as the flight path. In case of a cross wind, the aircraft attitude must vary (on the yaw axis) in order to maintain a constant and straight flight path, as required by the Scale Aerobatics rules (Fig. 2)

Also, a reduction in speed will force the aircraft to change its pitch in order to maintain the correct flight path (Fig. 3).

Depending the type of aircraft (low wing, high wing, etc.), the flight attitude might be different from one to another to maintain the correct flight path. Judges should disregard this difference in attitude and only concentrate on the flight path described by the aircraft.

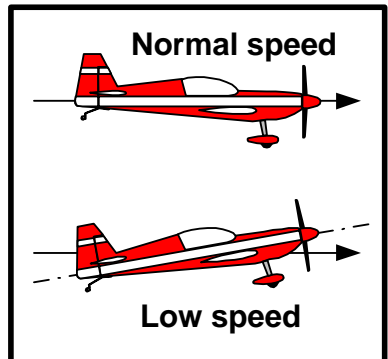

Fig. 3

At normal speed, the attitude is similar to the flight path. When the speed is reduced, the attitude may change to maintain a constant flight path.

5.3. Wind Correction. When judging a maneuver, understanding what constitutes wind correction, and what is not, is one of the toughest challenges. The general rule is that judges should ignore any aircraft change

of attitude required to maintain a correct flight path. At the same time, the usual 0.5 point deduction per 5 degrees of deviation shall be applied to anything that is not related with wind correcting. For instance, when the wind is blowing parallel to the flight path, the pilot flying a vertical line might use its elevator to change the aircraft's attitude in order to maintain a straight vertical flight path (Fig. 4).

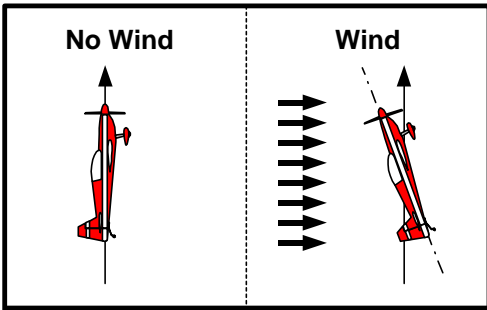

Fig. 4

For a vertical line with a wind parallel to the flight line, the aircraft attitude must be angled in order to maintain a constant flight path.

This change of attitude should not be downgraded. On the other hand, any bank angle of the wing in the roll axis should be downgraded using the standard rule of 0.5 point deduction per 5 degrees (Fig. 5). The judges should only downgrade for induced pilot corrections and disregard any sudden attitude changes due to wind bumps. Always give the competitor the benefit of the doubt when not sure.

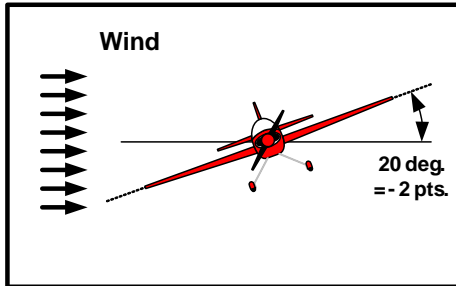

Fig. 5

In a cross wind situation, only the yaw axis is to be used for wind correction. Any change in the roll axis should not be considered wind correction and must be downgraded

The only maneuvers that are not to be wind corrected are the ones involving a stalled condition, such as a Stall Turn (otherwise known as “Hammerhead”), Tail Slide, spin and snap roll(s) (otherwise known as a “flick roll”). During the period of time that the aircraft is in a stalled, or near stalled condition, any wind drift should be disregarded by the judges and not downgraded.

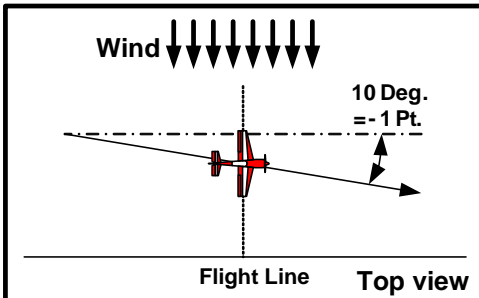

Fig. 6

Drift on horizontal line, due to cross wind should be penalized by ½ pt. per 5° deviation.

Wind correction should be used throughout the aerobatic airspace. Any drift observed on any line (horizontal, 45 degrees or vertical) should be downgraded using the 0.5 point deduction per 5 degrees rule (Fig. 6).

For instance, in the case of a Stall Turn performed with a severe crosswind, the vertical line will start directly after the ¼ loop. This is the first point of reference to be used for the upline. The flight path on the way up is 15 degrees off compared to the perfect vertical up line; the downgrade should then be 1.5 points.

When the aircraft starts its Stall Turn, it is in a stalled condition and no downgrade should be applied for wind drift during that time. Once the rotation is complete, a new reference point should be established for the perfect vertical downline. If the flight path on the downline is 20 degrees off, the downgrade should then be 2 points (Fig. 7).

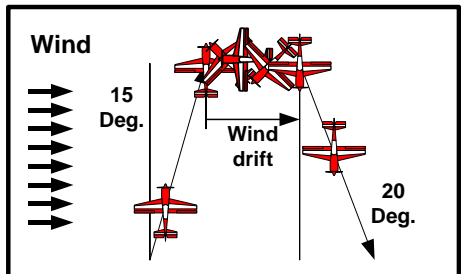

Fig. 7

In the case of a cross wind hammerhead, the above maneuver should not receive more than a 6.5 score (no downgrade for wind drift while stalled).

The competitor is required to make the shape of all maneuvers perfect regardless of the wind conditions. Loops and partial loops must be round, vertical lines must be perpendicular to the horizon and horizontal line parallel to the X or Y-axis. For 45-degree lines, judges must make an allowance for the aircraft's position relative to their own.

A true 45 degree line flown at the end of the aerobatic airspace will appear steeper when flown towards the end of the airspace and shallow when flown towards the center. Judging is of the true line flown and judges should not downgrade the maneuver for visual deformation due to the angle it is observed. Always give the competitor the benefit of the doubt when not sure.

6. Grading of Figures: The judges will independently assess the quality of each figure and its components as performed in the sequences, grading with numbers from ten (10) to zero (0) in increments of one-half (0.5) point. A grade of ten (10) represents a perfect figure in which the judge saw no deviations from prescribed criteria.

Remember, it is the judge's job to find fault: be a nitpicker. On the other hand, give a grade of 10 if you see a perfect figure—but if you are really being critical, you won't see too many. Don't get in a rut. Guard against confining your grades in too narrow a range. If you watch carefully and grade consistently, you will find yourself giving an occasional 2, 3, or 4 on some sloppy figures that are not quite bad enough for a zero. You will also be giving an occasional 9 or 10 for the superlative figure which you can find little or no fault.

As a judge, you are expected to grade only against one standard, and that is perfection. The performance of the aircraft, the difficulty in performing a figure (on the basis of your personal experience or perception), the weather condition or the pilot's name and reputation should not be considered in formulating your grade.

Two (2) judges should be used to judge each sequence. There should be enough judges available to establish a rotational procedure that will average out variations in judging. Sets of judges shall judge all contestants an equal number of times and all contestants shall have an equal opportunity to fly before all judges. Substitution of judges, which precludes equal exposure by all contestants, shall be avoided. If adverse weather conditions preclude equal exposure for all contestants, the results of the sequence may be disregarded at the discretion of the Contest Director.

6. Grading Principles

6.1: General principles. When grading the quality of the performance of individual figures, judges should consider the following general principles:

a: The geometry of the figures (including the shape, radii, angles, flight path, direction of flight, heading and bank angle) must comply with the prescribed criteria.

b: The precision of the performance compared to the criteria as explained later in this guide.

c: The smoothness of the performance

d: The distinctly recognizable start and finish of each figure with a horizontal line.

e: The figure must be the one depicted on the flimsy (Form B or C) appropriate to the direction of the flight chosen by the pilot to perform and

flown in its proper order within the sequence. For figures with a Y-axis component, it is the pilot's discretion, in addition to fly inbound or out bound, as to which direction to fly the turn, left or right. For Family 9, Rotational Elements it is the pilot's discretions to which direction to perform the roll or first roll, if it is unlinked roll combination. In all cases, the figure flown must have the entry and exit direction as depicted on the flimsy appropriate to the direction of flight chosen by the pilot to perform (Form B or C) in the X-axis.

f: The grading criteria of each component will apply in a combination figure so that one overall grade for the figure will result.

g: The length of the lines and the size of the radii caused by the flying characteristics of an aircraft are not to be taken into account in the grading.

h: Negative figures are graded by the same criteria as positive figures.

i: Speed of aircraft is not a criterion. A reduction of grade will be applied for each deviation from the prescribed criteria for the figure. The grade will be reduced by 0.5 points for each 5 degrees of deviation.

6.2: Beginning and ending of a figure. The first figure of a sequence begins at the moment the aircraft departs from its wings-level, horizontal flight path.

A figure is complete at the moment the aircraft returns to a wings-level, horizontal flight path of one fuselage plane length.

The only exception to this are the exit lines in the "ARESTI Aerobatic Catalogue (Condensed)", Families 7.4.3 and 7.4.4 (Square Loops) and 7.4.6 (Octagon Loops). Once a horizontal flight path of one fuselage plane length is established at the end of a figure, the beginning of the next figure is deemed to have occurred (Fig. 8). If an aircraft does not return to wings-level, horizontal flight before commencing the next figures the one (1) point per figure deduction will be applied. Ref. Rule 7. If the competitor corrects any errors in exit flight path, bank angle, or heading before initiating the subsequent figure, only the first figure shall be downgraded. Failure to correct such errors shall result in a downgrade to both figures.

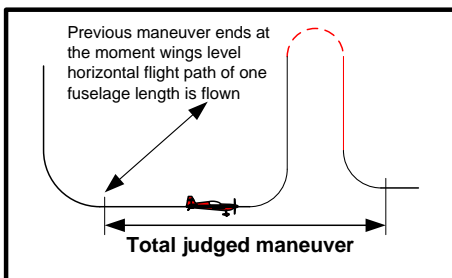

Fig. 8

The horizontal line prior the maneuver to be judged is also part of this maneuver, and therefore subject to the same downgrades as any other lines.

6.3: Zero. A zero will be given for:

a: Omitting a figure in the program. In this case, only the omitted figure will be zeroed. For instance, if the pilot omits the center maneuver and flies straight to do the next maneuver, only the center maneuver will receive a zero and the next maneuver will be scored normally.

b: Flying a figure that deviates from the ARESTI drawing held by the judges for scoring purposes. For instance, if the pilot flies a Humpty Bump instead of a Stall Turn, the maneuver will be zeroed.

c: Adding a figure to a program will zero the next following correct figure **except** when it is necessary to perform a Corrective Maneuver (c.1) due to the previous maneuver not being completed as per the program. A zero will be given to the figure immediately following any other added figure, even if the following figure is performed correctly.

c.1: A Corrective Maneuver can only be a turn of 270 degrees or less, and /or a roll of 180 degrees or less. In this case, a break penalty will be assessed against the competitor's raw score prior to normalizing.

For instance:

1: If the exit of a maneuver is done upright instead of inverted (the pilot forgot to perform a ½ roll on the downline), and corrects this by doing ½ roll after the exit, on the horizontal line, the original maneuver will be zeroed because the ½ roll was omitted on the downline, however the following maneuver will be scored because this ½ roll was added only to correct the attitude of the aircraft for the beginning of that next maneuver (Fig. 9). A break penalty will be applied, see **Rule 6.3.c.1**.

2: If the pilot exits the maneuver in the wrong direction on the X-axis (pull instead of push at the bottom of a figure), then adds a 180 degree turn and a 180 degree roll to correct the mistake and comes back to the correct flight direction he/she will be assessed a break penalty, see **Rule 6.3.c.1**. The original maneuver will be zeroed because the exit ¼ loop was not performed per the ARESTI, and the following

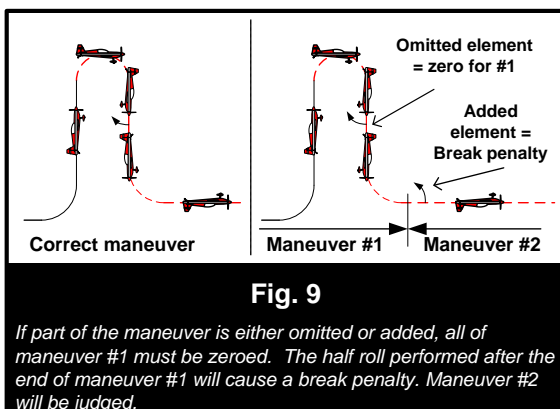

maneuver will be scored from wings level after the completion of the 180-degree turn and roll.

Note: Corrective actions that exceed 270 degrees of turn and or 180 degrees of roll constitute a Break in Sequence.

d: Break in the sequence. A break in the sequence is characterized by a total departure from the sequence to be flown. For instance, a pilot that becomes disoriented; aborts the maneuver and circles around a couple times before resuming the sequence again. Another example might be a pilot that aborts a maneuver thinking that the aircraft has equipment problems, makes a couple of fly-bys in order to confirm that everything

is operating normal, and then decides to resume the sequence. A deadstick, or a landing during the sequence shall not be considered as a break and all remaining maneuvers that were not flown will be zeroed.

Break Penalties (deducted from raw scores prior to normalization.)	
Basic	10 pts
Sportsman	20 pts
Intermediate	40 pts
Advanced	70 pts
Unlimited	100 pts

When a Break in Sequence occurs, the figure in progress (at the time of the break) should be zeroed and a break penalty will be assessed against the competitor's raw score prior to normalizing. Situations may occur where a pilot performs an incorrect maneuver, resulting in a zero, exits that maneuver improperly, and then performs a break in sequence. In this instance, the pilot receives a zero for the first failed maneuver, and a zero for the next maneuver in which the Break in Sequence occurred (Fig. 10).

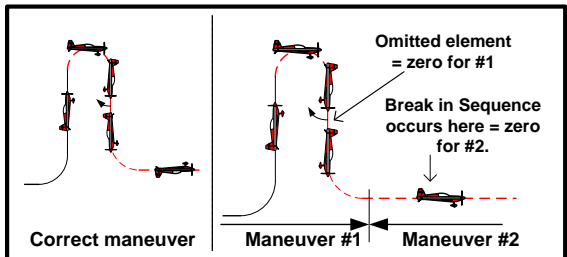

Fig. 10

If part of the maneuver is either omitted or added, all of maneuver #1 must be zeroed. If a Break in Sequence occurs at the start of #2, it is a zero and re-fly #2 on re-entry of sequence.

Resumption of scored flight: The pilot or the caller should verbally indicate to the judges his intention to resume the sequence. He should then first establish a wing-level horizontal line, call the restart of the sequence to get the judges' attention, perform the last flown maneuver that is to be zeroed, and continue the sequence from there on. Normal judging will resume after the completion of the zeroed maneuver.

A break in the sequence related to safety, weather, for collision avoidance, or by request from the judges or the Contest Director will not be penalized.

e: Flying a figure in the wrong direction on the X-axis. The Y-axis is non-directional.

f: Any cumulative deviation in excess of 90 degrees in the roll, pitch or yaw axes that are not related to wind corrections.

g: Any figure or figures started and flown completely or partially on the pilot side of the deadline. The aircraft must clearly penetrate the deadline to receive a zero.

Judges should score each figure independently and not communicate with each other while judging of the sequence. Once the sequence is complete, the judges may, but are not required to, confer and review any figure receiving a zero, but need not agree on the score.

If a judge misses one or more figure, or any part of a figure, such that a grade cannot be given with full confidence, the judge should then leave the score sheet space(s) empty until the sequence is complete. He/she should then confer with the other judge and use his score for the missing figure(s). If both (or all) judges, for any reason, are not able to grade a figure with full confidence, they shall ask the pilot to re-fly the missed figure beginning with the figure prior to the missed figure. Only the missed figure will be scored in this case.

7. Basic Components of Aerobatics:

7.1: Lines. All lines are judged in relation to the true horizon and the axes of the Aerobatic Airspace. Horizontal and Vertical lines are judged primarily on flight path (Ref Rule 5.3 for wind correction criteria).

All figures begin and end on definite horizontal lines, and both must be present in order to earn a good grade. A competitor who rushes from one figure to another, without showing this horizontal and well-recognizable line will be downgraded by one (1) point for each missing line in each figure affected.

Therefore, leaving out the line between two figures will downgrade the preceding figure by one (1) point and the following figure also by one (1) point (Fig. 11).

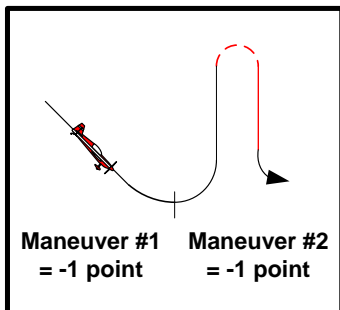

Fig. 11

No visible horizontal line between two maneuvers is a downgrade of (1) point for each maneuver.

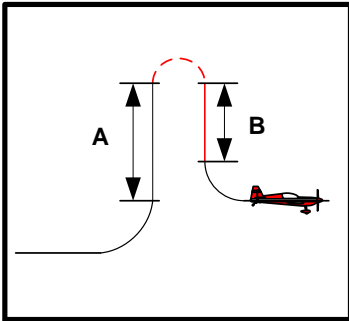

Fig. 12

Length of lines A & B are defined as starting on and ending with part loops.

All lines that occur inside a figure have a beginning and an end that define their length. They are preceded and followed by part-loops (Fig 12).

With the exception of Family 3 figures (Three, Four & Eight Corners) and some figures in Family 7 (Loops and Eights), the criterion for the length of lines within a figure states that they do not have to be of equal length (Fig. 12). For example, the length of the lines in a Single Humpty-bump do not need to be equal, but all four lines in a Square Loop must be of equal length (Fig. 13).

Whenever any kind of roll is placed on an interior line, the lengths of the two parts of the line before and after the roll must be equal. Exceptions are when any type of roll follows a spin element. Judges should take care to judge the symmetry of the length of lines in a figure using only the length of the lines and not be elapsed time taken to fly each segment. This difference in length versus elapsed time is most noticeable in figures where rolls are placed on up-lines. As the aircraft loses airspeed, the time it takes to fly a line after the roll will be greater than the time required to fly the line of the same length before the roll.

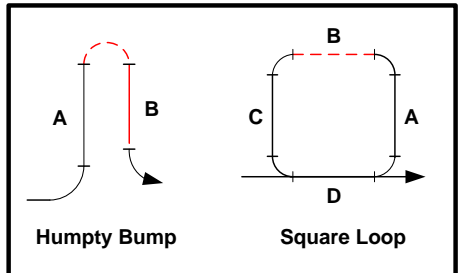
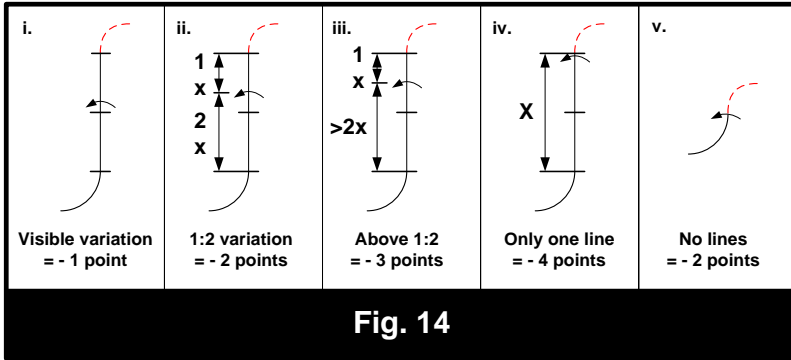

Fig. 13

*Humpty: Length A does not need to equal B
Square Loop: Length A shall equal B = C = D*



If within a figure two or more lines must be of the same length, an observed variation is penalized by the grade in the following manner (Fig. 14):

- i. A visible variation = 1 point deduction
- ii. If the lengths vary by 1:2 = 2 point deduction
- iii. And so forth up to a 3 point deduction
- iv. No line before or after roll, 4 point deduction.
- v. No line at all before and after roll = 2 point deduction.

The basis for judging line length is the first line flown. The absence of one of these lines either before OR after a roll has to be penalized by one (1) additional point. IF there are no lines before AND after the roll, the total penalty is two (2) points only.

Example: The competitor is to fly a vertical up-line with a full roll on the line. However, the aircraft is returned to level flight immediately after the roll. The deduction is 4 points: 3 points are deducted because the lines are of vastly different length and another 1 point is deducted because of the absence of one of the lines.

7.2: Loops and part-loops. The loop is a figure from Family 7, but part-loops are integral to every other family so it is necessary to discuss the loop before going on to the other families.

7.2.1: General Criteria. A loop must have, by definition, a constant radius. It starts and ends in a well-defined line that, for a complete loop, will be horizontal. For a part-loop however, such lines may be in any other plane of flight. As the speed changes during execution of a loop or part-loop, the angular velocity around the aircraft's lateral axis also has to change in order to keep the radius constant. When the speed decreases, for example, to half its

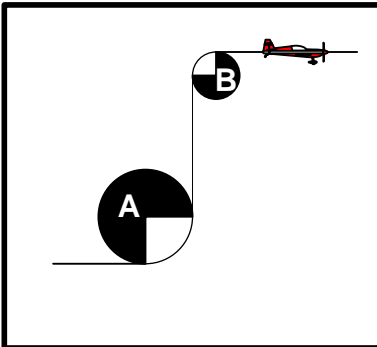

Fig. 15

A & B radii do not need to match

initial rate, the angular velocity, to keep the same radius, will be reduced by half—this is a fact of physics. Thus, the angular velocity can be an aid for the judge to gauge the radius—especially when the angular velocity in the higher part-loop is seen to be faster, as this is a clear indication that the radius is smaller. This aid becomes more important when a line separates two part-loops. Refer to section 8.7 for specific criteria for judging loops and part loops.

7.2.2: Matching Radii. Certain figures require that the part-loop portion of the figure have the same radius. When identical radii are required depends on the figure in question. This is defined by how a particular figure is depicted (drawn) in the ARESTI Aerobatic Catalogue.

7.2.2a: Round Corners. For any figure having more than one internal part-loop depicted in the catalogue as an actual round, or looping line, element, all such part-loops must have the same radius – with an exception for all of Family 8.8 (Double Humpty Bumps). For those figures, the radius of the second half-loop is not required to match the radius of the first one.

7.2.2b: Corner Angles. For any figure having more than one internal part-loop depicted in the catalogue with a hard, or corner angle, no such part-loop is required to match the radius of any other part-loop depicted in the same figure – with the exception of figures which must maintain a set geometric proportion, i.e.,

- a) All of Family 3 (Combination of Lines)
- b) Family 7.4.3.x to 7.4.6.x (Hesitation Loops)

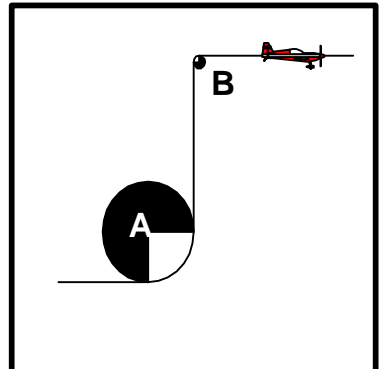

Fig. 16

Sharp angles, or 'corners' must be downgraded.

For example, the quarter-loop at the top of the vertical line (Family 1 figure) need not have the same size radius as the quarter-loop at the bottom (Fig. 15). However, the top radius must not be “corner” or very sharp angle (Fig. 16). It must have a smooth, distinct, and constant radius.

8. FAI “ARESTI Aerobic Catalogue (Condensed)” Families:

8.1: Family 1: Lines and Angles. Family 1.1.1 to 1.1.11 has been fully covered in the preceding section. Note that the figures in Family 1.2.1 to 1.2.16 are NOT performed as drawn in the “ARESTI Aerobic Catalogue (Condensed)”. In each of these figures there are three looping components: a one-eight loop, a three-eight loop and a quarter loop. Rolls may be performed on the 45-degree line and/or the 90-degree line, with the part line being of equal length. The initial horizontal line and the line at the end of the figure may be flown at different altitudes (Fig. 17).

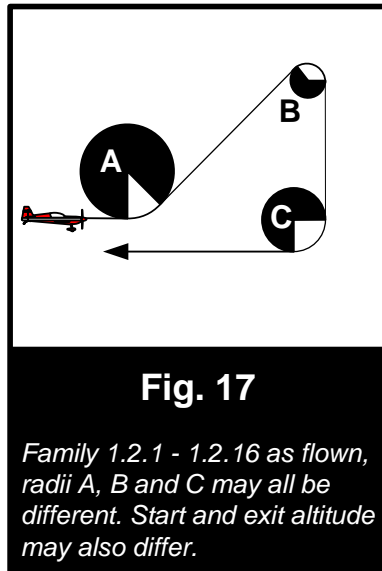

8.2: Family 2: Turns and Rolling Turns.

8.2.1: Turns. In aerobic competition, a turn is divided into three parts:

- 1: Establishing the bank using a roll on heading.
- 2: The turn itself.
- 3: A roll back to straight and level flight on heading.

Let’s look at the turn during each of these three parts. First, the roll to establish the bank. This must be a roll of between 60 and 90 degrees; it must be performed on the entry heading; and the aircraft must maintain a constant horizontal line. Once the roll is completed and the angle of bank is established, the competitor immediately performs the turn. The turn must maintain the established angle of bank throughout. The aircraft must also maintain horizontal flight. The rate of turn is constant throughout and the maneuver must be wind corrected so that, for instance, a 360-degree turn will be a

perfect circle. It should be noted that the wind correction cannot be performed by visibly changing the bank angle.

As soon as the aircraft is on the exit heading, the competitor performs another roll at a rate equal to the entry roll. Again, the aircraft must maintain a constant horizontal line.

Downgrades:

a: The angle of bank established by the initial rolling maneuver must be at least 60 degrees and not greater than 90 degrees. Any less or more is a 0.5 point deduction for every 5 degrees.

b: The angle of bank, once established, must remain constant. Any deviation is a 0.5 point deduction for every 5 degrees of deviation.

c: The rate of roll must be the same for the entry and exit rolls of this figure. Any deviation is a one (1) point deduction.

d: The aircraft must maintain a constant altitude throughout the figure. Any variation would be 0.5 point deduction for every 5 degrees of change.

e: The rate of turn must remain constant. Any change would be not more than a one (1) point deduction for each change. Note that the rate of turn may appear to change in a strong wind, when it really isn't changing. The judges must always keep the wind in mind and give the pilot the benefit of the doubt if there is any question.

f: The aircraft must begin and end on the prescribed heading. Any deviation is a 0.5 point deduction for every 5 degrees of deviation.

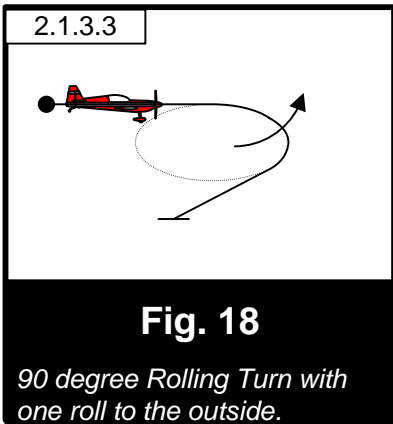

8.2.2: Rolling Turns. The rolling turn is a figure that combines a turn of a prescribed amount with a roll or rolls integrated throughout the turn. The rolls integrated into the turn may be in the same direction as the turn and are called “rolls to the inside” or may be in the opposite direction of the turn and are then called “rolls to the outside” (Fig. 18). There can also be rolls alternating in and out. The direction of these rolls, to the inside or to the outside, must be flown exactly as depicted in the ARESTI. When we say that the rolls are integrated, we are

saying that in addition to there being constant rate of turn throughout the figure, there is also a constant rate of roll throughout. Naturally, the one

exception to this constant roll rate is the pause when reversing roll direction. In addition, the entire maneuver is to be flown at a constant altitude.

To help visualize the execution of this figure and facilitate a way for the judges to determine a constant roll rate, let's look at an aircraft performing a 360 degree rolling turn with 4 rolls to the inside from upright (Family 2.4.7.1). First, on the prescribed entry heading, the pilot executes a turn and simultaneously initiates a roll in the same direction as the turn. The judges will expect the aircraft to be inverted at 45, 135, 225 and 315 degrees and to be upright at 90, 180, 270 and 360 degrees. At these interim headings, the judge will NOT downgrade using the 0.5 point for 5 degree rule but will judge changes in the rate of roll, changes in the rate of turn and changes in altitude. At the end of the 4 rolls, the aircraft must have terminated its 360 degree turn and finish at the same point where it started, wings level and on the prescribed heading.

When a rolling turn is performed with rolls alternating directions, the aircraft must change direction of roll at a wings level attitude. The position of the aircraft in the turn is still only used as an aid to determine if the pilot is varying the rate of roll or turn.

Downgrades:

- a:** Performing more or fewer rolls than the ARESTI description calls for, or rolling in a direction different than depicted on the ARESTI results in the figure being zeroed.
- b:** All rolls in a rolling turn are standard rolls. If a snap roll is performed, the figure is zeroed.
- c:** Each stoppage of the rate of roll is a deduction of one (1) point.
- d:** Each variation in the rate of roll is a one (1) point deduction.
- e:** Each variation in the rate of turn is a one (1) point deduction.
- f:** Variations in altitude are deducted using 0.5 points per every 5 degrees difference.
- g:** 0.5 points per every 5 degrees that the aircraft is not in level flight when reversing roll direction.
- h:** 0.5 points for every 5 degrees of roll remaining when the aircraft has reached its heading.
- i:** 0.5 points for every 5 degrees of turn remaining when the aircraft has completed its last roll.

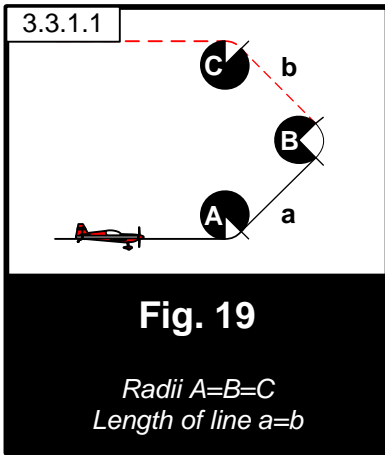

8.3. Family 3: Combinations of Lines. For all the figures in Family 3, (Three Corners, Four Corners, and Eight Corners) the transition from level flight to a 45 degree line should be at a constant and reasonable one eighth (1/8) looping radius. All lines within the figure should be equal in length. All part loops within the figure should be of identical radii. The 45-degree transitions in Family 3 should have a constant radius and not a sharp corner (Fig. 19). The basis for judging line length is the first line flown. Refer to rule 7.1 for downgrades.

The radius of all part loops in the figure are measured against the first part loop flown in the maneuver. Thereafter, each part loop flown within the maneuver that has a different radius than the first part loop flown receives a one (1) point deduction.

Each part loop flown in the maneuver must have a constant radius. Each variation of radius within a part loop receives a one (1) point deduction.

8.4: Family 4: Not in use.

8.5: Family 5.2-5.4: Stall Turns.

flight thus ending the figure (Fig 20). Stall Turns, also referred to as “Hammerheads”, are some of the most graceful figures in the “ARESTI Aerobatic Catalogue (Condensed).” In its most basic form, the figure begins when the aircraft leaves horizontal flight and flies a one-quarter loop to establish a vertical climb or flies a one-eighth loop to establish a 45 degree up line. If the entry is a one-eighth loop to a 45 degree line then, having presented that line, the aircraft will fly another one-eighth loop and establish a vertical up line. At the top of the vertical line, the aircraft stops, pivots and establishes a vertical descent. The vertical line may terminate in a one-quarter loop which will return the aircraft to horizontal flight and end the figure. Or, after the vertical descent from the peak, the aircraft may fly a one-eighth loop to a 45 degree down line. Having presented this line, the aircraft will fly another one-eighth loop to return to horizontal

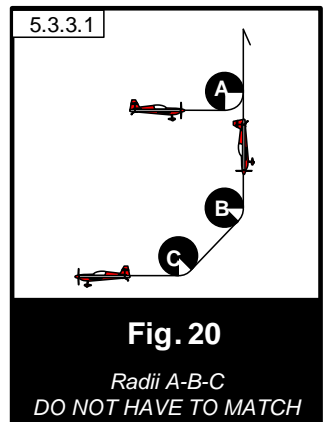

The judging criteria are:

a: The up and down lines, vertical or 45 degree, must be wind corrected so that they are flown as a straight line at the correct angle to the horizon.

b: On the up and down lines, any roll deviation, or deviation of the track of the aircraft in pitch or yaw will result in a deduction of 0.5 points per 5 degrees of deviation.

c: Any added roll element(s) on the vertical or 45 degree lines must be positioned so that the line segments before and after the roll elements are of equal length (Fig 21).

d: The length of the up and down lines, vertical or 45 degree, need not be equal. Therefore, the altitude of the horizontal lines at the entry and exit of the hammerhead may be different and no downgrade applies for this difference.

e: As the aircraft nears the point where it stops climbing, it must pivot in a plane parallel to vertical. Any alignment deviation from parallel to the vertical should be downgraded 0.5 points for each 5 degrees of deviation.

f: When the aircraft pivots at the top of the vertical line in a stalled or near stalled condition, no deduction should be applied for wind drift during that particular time.

g: In the case of strong cross winds, the aircraft will most probably be “crabbing” to wind correct the up and down lines. The pivot at the top of the line might therefore be less or more than 180 degrees and no downgrade should be applied to it.

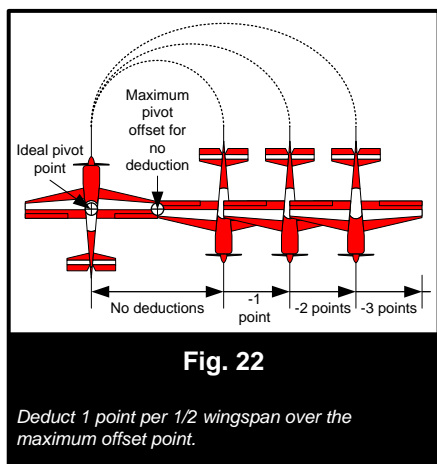
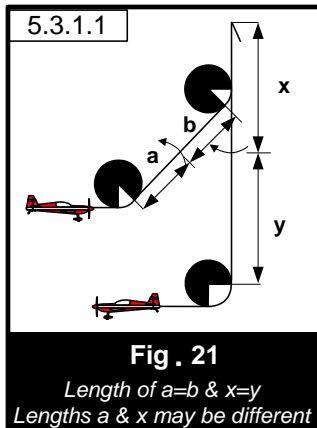

h: Any pendulum movement observed after the pivot is subject to downgrade at 0.5 points per 5 degrees of movement off the vertical. This downgrade is applied for each movement either side of the vertical.

When rotating at the top of the maneuver, ideally, the aircraft pivots around its center of gravity. To avoid a deduction, the aircraft must pivot around an axis point, which cannot be farther away from its center of gravity on the vertical up line than its wingtip ($\frac{1}{2}$ wingspan). The downgrade for this deviation is one (1) point per half wingspan that the point of rotation exceeds the maximum allowed (Fig 22).

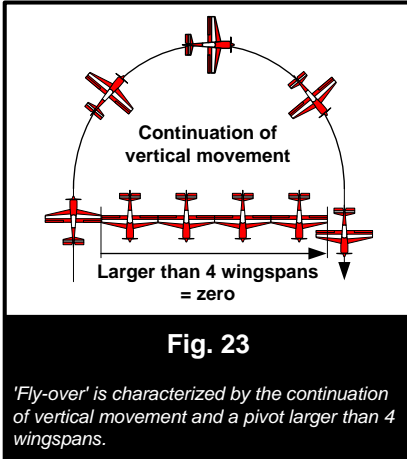

characterized by the continuation of vertical movement and a pivot larger than 4 wingspans. A “fly-over” Stall Turn should be zeroed (Fig 23).

The maneuver should also be zeroed if any distinctive backward sliding movement is observed before the start of the pivot, even if the rotation is correctly performed after the slide (Fig. 24). The rate at which the aircraft pivots around its vertical axis is not a judging criterion.

During the pivot, the wings must remain in the vertical geometric plane as dictated by the ARESTI. This alignment must be maintained throughout the pivot, and the aircraft's attitude at the beginning and the ending of the pivot must be absolutely vertical. During the pivot there must be no deviation in pitch or roll. Any pitch and roll deviation observed during the pivot should be

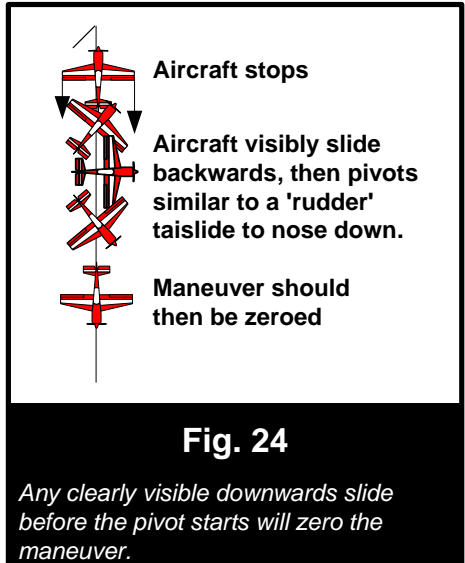

Judges must be careful to deduct only for true extended turnaround, and not for any apparent deviation caused by wind drift during the pivot. One way to recognize a “fly-over” from a wind drift will be that the “fly-over” is generally

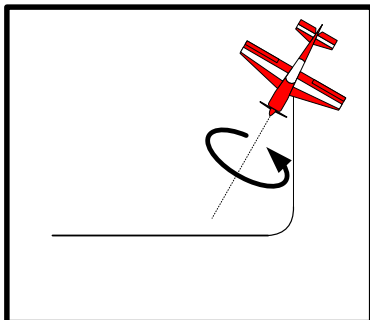

Fig. 25

'Torquing' is a rotation around the roll axis during the turnaround.

downgraded at 0.5 points for each 5 degrees of deviation. Such movement around the roll axis during the pivot is often referred to as “torquing” (Fig 25).

8.6: Family 6.2: Two Line Tail Slides. All the criteria of the Stall Turn apply to this figure except, of course, for the maneuver at the top of the vertical climb. At the point when the aircraft stops climbing, it must slide backwards a visible amount in the vertical plane. The key here is “visible” and “vertical plane.” If the aircraft pivots directly on the top, without any clearly visible slide, the maneuver should then be

zeroed (0). Following the slide backwards, the aircraft must then tip over and fall through to a diving position. Often the nose will swing back or “pendulum” in pitch past the vertical after falling through. The figure is not to be downgraded for this, nor downgraded if it does not happen. It is a function of the length of the slide and the type of aircraft, and is not to be considered in grading the figure.

There are two types of Tail Slides: wheels-down and wheels-up. The wheels-down Tail Slide is depicted in the

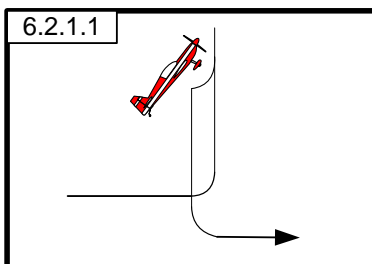

6.2.1.1

Fig. 26

Wheels down Tailslide

ARESTI diagram with a curved solid line at the top of the Tail Slide symbol (Fig. 26). The wheels-up Tail Slide is depicted in the ARESTI diagram with a curved dashed line at the top of the Tail Slide symbol (Fig. 27).

This figure must be watched carefully, as the aircraft can fall the wrong way (which is graded a zero) with the

correct direction of flight and the proper aircraft attitude still maintained.

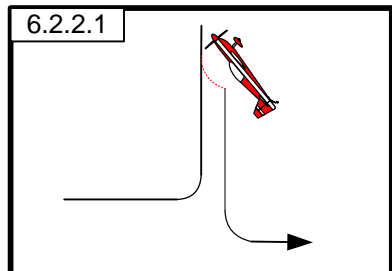

6.2.2.1

Fig. 27

*Wheels up Tailslide
Radii A and B can be different.*

6.2.2.1

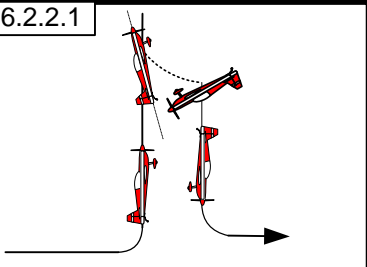

Fig. 28

Any change of attitude done right before the stall, to favor the type of tailslide will be downgraded ½ point per 5°.

The judging criteria are:

a: All lines and arcs flown in the maneuver are to be wind corrected and correctly aligned within the airspace as described in sections 5.3, 7.1 and 7.2. Observed alignment deviations receive a deduction of 0.5 points for each 5 degrees of deviation.

b: Absence of any visible backward slide in the vertical plane zero's the entire maneuver.

c: On all up and down lines, the roll attitude must be perpendicular to the plane of the main axis of flight, either the X or Y axis. This includes the duration of the fall through. Watch for the aircraft torquing off the correct

plane of flight. Any deviation in roll should be downgraded at 0.5 points per five (5) degrees of deviation.

d: As with the Stall Turn, the aircraft will be in a stalled or near-stalled condition at the top of the vertical line and no deduction for wind drift should be applied during that particular time..

e: The altitude of the entry and exit horizontal lines need not be the same and the figure must not be downgraded if they are different.

f: When rolls are combined with Family 6 figures, the line segments before and after the roll(s) must be of equal length. Refer to rule 7.1 for downgrades.

g: After performing the Tail Slide at the peak of the maneuver, the aircraft must establish a visible vertical down line. If this line is omitted, a downgrade of one (1) point is to be applied.

In summary, the aircraft should make a smooth and steady transition up to vertical flight, and the aircraft should come to a complete stop in this attitude. After sliding backward a visible amount, it should fall through in the appropriate direction without dropping a wing or the nose moving off axis, and recover on the same plane as that of entry. After completion of this, it should again project the 90-degree down line (wind corrected if required) before transitioning into horizontal flight with a quarter loop.

8.7: Family 7: Loops and Eights.

8.7.1: General Principles: Family seven figures are covered in the following sections in groups, sections 8.7.2 to 8.7.8. Each section provides the maneuver description and the overall judging criteria for the group. Each section also provides, for the most part, the downgrades to be applied for

deviations. However, some downgrades in some of the sections are not completely specified and, as such, are described here:

a. The size of a loop or part loop is not a grading criterion. It will vary according to the flight characteristics of the aircraft. A large loop is not graded any higher or lower than a small loop, but any variation to the radius will downgrade these figures

b. All radii are to be constant. Each visible variation in the radii in a loop or part loop is to be downgraded by one (1) point.

c. Where radii of part loops within these figures are required to be the same and they are not, a downgrade of one (1) point is to be applied for each mismatch. The standard is the first part loop flown within the figure.

d. Where complete loops or part loops within these figures are required to be the same size and they are not, a downgrade of one (1) point per mismatch is to be applied.

e. Roll elements that are to be done on a line must be centered and are to define two equal length line segments, one either side of the roll element. Refer to rule 7.1 for downgrades.

f. Where a roll element is to be done entering or exiting a part loop there is to be no line shown between the part loop and the roll element. The downgrade for showing a line in these situations is a minimum of two points.

g. Where a roll element is to be done on a line between two vertical half loops, or between two full loops that form a vertical eight, and the line is absent, a downgrade of two (2) points is to be applied. There are to be no lines before or after the roll element and, if present, each such added line should result in a two (2) point deduction.

8.7.2: Family 7.2: Half Loops

The half-loops in this sub-family must be of a constant radius and wind-corrected to appear as a perfect half circle (see full loop discussion below). When a half-loop is preceded by a roll or rolls, the half-loop follows immediately after the roll(s) without any visible line. Drawing a line requires a downgrade of at least two (2) points depending on the length of the line drawn. Should the half-loop begin before the roll is completed, the judge must downgrade the figure 0.5 points for

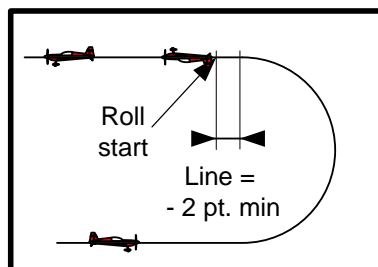

Fig. 29

Drawing a line after the 1/2 loop is a minimum downgrade of 2 points.

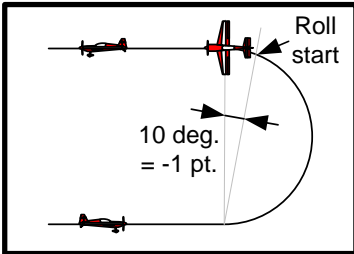

Fig. 30

Aircraft starting the roll ten degrees early before reaching horizontal flight = - 1 point

every 5 degrees of half-loop flown on which the roll was performed.

The half-loop followed by a roll is also flown with no line between the half-loop and roll. Again, drawing a line requires a downgrade of at least 2 points depending on the length of the line drawn (Fig. 29). Should the roll begin before the half-loop is completed, the judges must downgrade the figure 0.5 points for every 5 degrees of half-loop on which the roll was performed (Fig. 30). Great care should be taken here to differentiate

between aircraft airfoils and the slow speed at the top of the half loop + roll maneuver. The aircraft will appear to begin the roll before reaching horizontal flight due to its high pitch attitude. As the aircraft accelerates, it will then establish a cruise pitch attitude.

8.7.3: Family 7.3: Three-Quarter Loops: Sometimes referred to as “Goldfish” (Fig 31), the entry and exit loop radii in these figures do not have to be identical. The radii of the three-

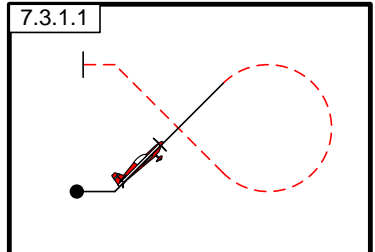

Fig. 31

Three-Quarter Loops or "Goldfish"

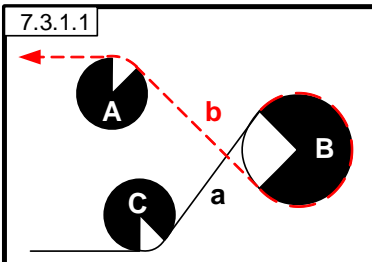

Fig. 32

Radii A – B – C may be different. Lines a and b do not have to be the same length.

quarter (3/4) loop is not required to match that of the entry or the exit loop radii (Fig. 32). The entry and exit lines are judged with reference to the 45 degree flight path. Any rolls on the 45 degree lines must be centered on that line. It is not required that the lengths of the 45 degree lines bear any strict relation to the diameter of the three-quarter (3/4) loop. That is, the entry and exit altitudes need not correspond to the altitude limits of the loop.

7.4.1.1

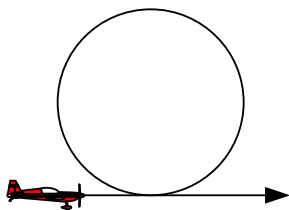

Fig. 33

Full loops must appear perfectly round to the judges.

8.7.4: Family 7.4: Whole Loops

8.7.4.a: Round Loops (7.4.1 – 7.4.2) All whole round loops must appear perfectly round to the judge (Fig 33). If required, they must be wind corrected to have a constant radius. This wind correction is not only with regards to the roundness of the loop but also for the effect of any crosswind on the figure. Therefore, a standard deduction of 0.5 points per five (5) degrees should be applied if the finish point is displaced in a direction perpendicular to the plane

of the loop (Fig. 34). In a heavy crosswind situation, a loop might be flown with visible crabbing and no deduction should be applied in this case.

To better quantify deductions for loops, the judges should watch for these irregularities: perpendicular displacement, change of radius, aircraft roll and flat spots (aircraft without a flight path radius) within the loop.

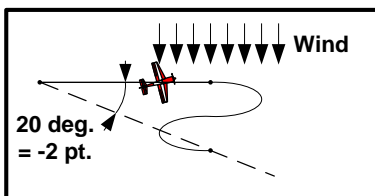

Fig. 34

The ½ pt. per 5 degrees rule apply for any wind drift during the loop, in this case -2 pt. for 20 degrees.

Deductions are as follows:

- a. As stated in first paragraph, 0.5 points per five degrees for perpendicular displacement.
- b. A variation in the radius will be a one point deduction per occurrence.
- c. Aircraft displaying any roll other than during a roll element on the loop, 0.5 point per five degrees of roll.

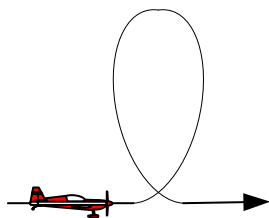

Fig. 35

"L shaped" loop

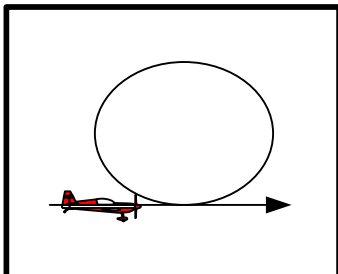

Fig. 36

"Egg shaped" loop

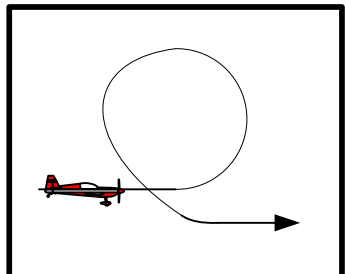

Fig. 37

"E shaped" loop

d. Flight path without any radius (straight line or “flat spot”), one point per occurrence. In judging loops, a common error is for the vertical diameter of the loop to be larger than the horizontal diameter. This is often called an “L” shaped loop (Fig. 35). Less common are loops with a horizontal diameter greater than the vertical. This is called an egg-shaped loop (Fig. 36).

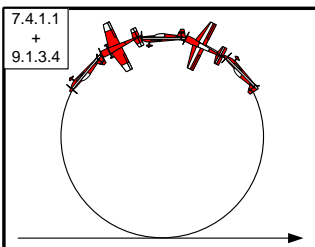

Fig. 38

A rolling element on a loop must be flown centered, at the apex, and on the arc of the loop.

Another common error is in varying the radius of the final quadrant performing an “e” shaped loop (Fig. 37). The downgrades listed above should be applied for each of these errors.

a two (2) point downgrade. If the roll is not centered, it must be downgraded 0.5 points for every five degrees that it is off center.

If there is a rolling element (roll, point rolls or snap roll) at the apex of the loop, it must be centered in the loop and flown on the arc of the loop itself (Fig. 38). Flying the roll on a line at the apex of the loop is at least

8.7.4.b: Family 7.4.3- 7.4.6:

Square, Diamond and Octagon Loops.

Square and Octagon loops are flown as hesitation loops with lines of equal length and partial loops with equal radii (Fig. 39). Square and Octagon loops are not considered complete until the last horizontal line is drawn equal to the length of the first line of the figure.

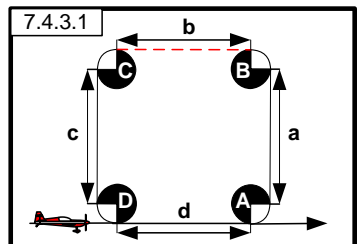

Fig. 39

*Radii A=B=C=D
Length a=b=c=d
Figure not finished until d=a*

All horizontal, vertical, and 45-degree lines are judged on flight path and should therefore be wind corrected. As such, the judge should always expect to see these figures closed, the same way as a round loop.

Where rolls are flown on the Square or Diamond loops, they must be centered on the line. Aids for judging all hesitation loops are that a good performance will contain changes of angular velocity in all the partial loops, and variations of time taken to draw the length of each interior line, which also varies according to the aircraft's speed. The rhythm of all these partial loops is a help for judging.

8.7.4c: Family 7.4.7-7.4.14: Reversing Whole Loops Reversing Whole Loops shall be judged using the same criteria for Whole Loops. No line is to be flown between the $\frac{1}{4}$ and $\frac{3}{4}$ loop segments, and the radii of all loop segments must be equal (Fig 39a). Drawing a line between the loop segments requires a downgrade of at least two (2) points depending on the length of the line drawn. Rolls placed either before or after the Reversing Whole Loop shall

be flown with no line segment between the roll and the loop. Drawing a line requires a downgrade of at least two (2) points depending on the length of the line drawn. Any rolling element flown at the apex (top of loop) or bottom of the loop shall be judged in accordance with the rules for Whole Loops found in paragraph 8.7.4.a.

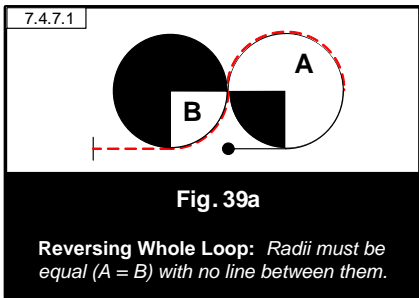

8.7.5a. Family 7.5.1-7.5.8: Horizontal "S"s. Horizontal "S"s may be described as two Half Cubans joined together, sharing a common 45 degree line. In these figures, both $\frac{5}{8}$ ths loops must have the same radii (Fig 39b). When the looping portion of the figure is immediately preceded by (on entry) or followed by (on exit) a roll or rolls, there must be no visible line between the roll and loop elements.

Drawing a line requires a downgrade of at least two (2) points depending on the length of the line drawn. This criterion is not meant to imply that one element (roll or loop) must start before the preceding element is completely finished. A brief hesitation between elements (similar to opposite rolls) should not be downgraded.

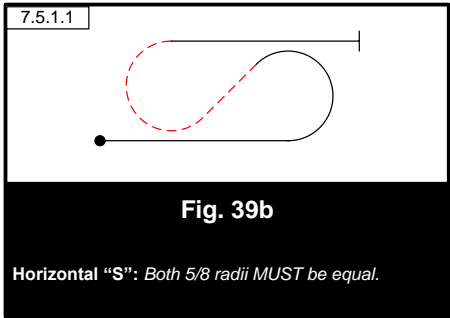

Any rolls that are placed on the 45-degree line (between the two 5/8ths looping portions) must be centered on the line, and do not follow or precede the looping portions as described above.

8.7.5b. Family 7.5.9-7.5.10: Vertical “S”s. These figures are accomplished with two joined half-loops flown in opposite directions (Fig.40). Look for both half-loops to be the same size and perfectly round. The half-loops should be a continuous looping figure when there is no half roll between the half-loops.

When a half roll is performed between the half loops (full roll(s) are not authorized), there is no line before or after the half roll. However, the half roll is flown on a horizontal line which begins as soon as the first half-loop is finished. As soon as the half roll is finished, the next half-loop must begin immediately (Fig. 41). Adding a line at either of these points is at least a two (2) point deduction, depending on the length of the line.

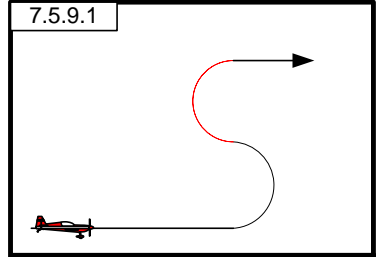

Fig. 40
Both half-loops must have equal radii.

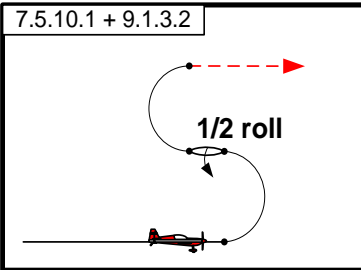

Fig. 41
A half roll between two half loops must be flown on a horizontal line.

8.7.6: Not in Use

8.7.7: Not in Use

8.7.8a: Family 7.8.1 - 7.8.8: Horizontal Eights. Also referred to as “Cuban Eights,” the 5/8th and 3/4 loops must have the same radii; lines between the loops flown at exactly 45 degrees (Fig. 42). Wind correction shall be applied throughout the figure so that the 45-degree lines intersect at the exact mid-point of the Horizontal Eight. If there are roll elements on the 45 degree line(s), they will be positioned so that the lines before and after the roll are of equal length. When the 5/8th loop portion is

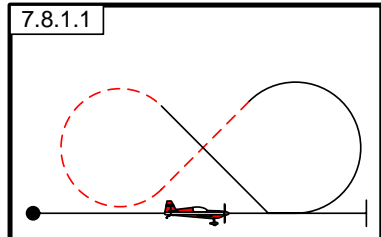

Fig. 42
Horizontal 8. Both loop radii must be equal. 1/8 loop (entry or exit) radius may be different from horizontal 8 loop radii.

preceded or followed by a roll element, there must be no visible line between the roll element and the 5/8th loop. Inserting a line between the roll element and 5/8th loop portion requires a minimum downgrade of 2 points.

The start and finish of the figure and the bottoms (or tops if reversed) of the 5/8th and 3/4 loops must be at the same altitude.

The radius of the 1/8 loop between the 45 degree line and horizontal flight need not equal the radii of the 5/8th and 3/4 loops of the Horizontal 8.

8.7.8b: Family 7.8.9 - 7.8.16: Horizontal Super “8”s. Besides possessing the unique characteristic of containing three 45-degree lines on which rolls may potentially be placed, this family can be thought of as two linked Three-Quarter Loops (Family 7.3).

The radii of the two 3/4 loops must be identical to each other. However, the radii of the two three-quarter (3/4) loops are not required to match the radii of the entry or exit loops. Each of the 45-degree lines may be of different lengths, but any rolls placed on them must be centered. The two 3/4 loops need not occur at the same altitude, nor is there any relationship between the horizontal entry/exit altitude and the altitude limits of the two 3/4 loops (Fig. 43).

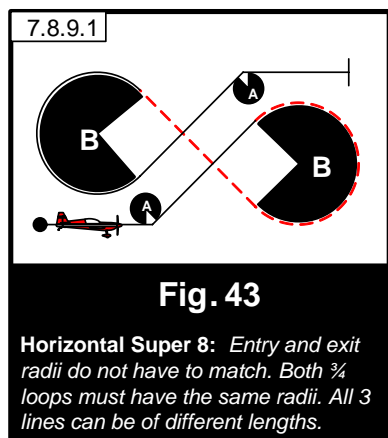

8.7.8c: Family 7.8.17 – 7.8.22: Vertical “8”s. These figures are performed by flying two loops, one above the other (Fig. 44).

Sub-family 7.8.17-7.8.20 is composed of two loops, both above or both below the entry altitude. Sub-family 7.8.21 - 7.8.22 is composed of one loop above and one loop below the entry altitude. In either case, the entry and exit altitude must be the same.

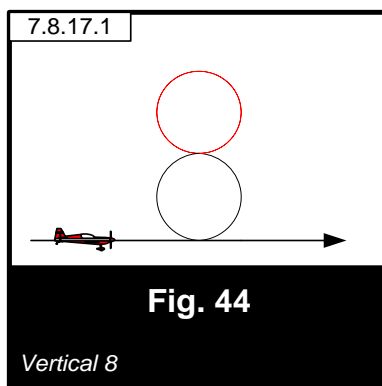

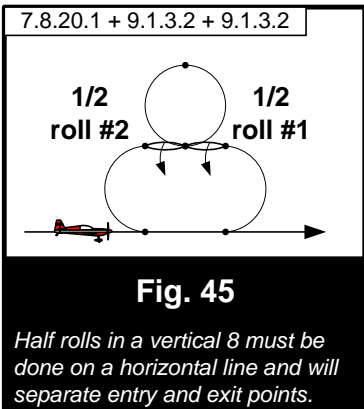

These figures may be combined with various types of half rolls. When a half roll is performed between the loops, there is no line before or after the half roll. However, the half roll is flown on a horizontal line that begins as soon as the first loop is finished. As soon as the half roll is finished, the next loop must begin immediately. Adding a line at either of these points is at least a two (2) point deduction depending on the length of the line. These figures are to be graded using the same criteria as full loops.

Additionally, both loops must be of the same size. Unless there is a half roll between the loops, they must be directly above one another. Here as well, the beginning and the end point of the maneuver will not be in the same vertical plane if a half roll is flown between the loops (Fig. 45). This should not be a reason for downgrade.

8.8: Family 8: Combination of Lines, Loops, and Rolls.

8.8.1 – General Principles: Family 8 figures are covered in the following sections. Each section provides the maneuver description and the overall judging criteria for the group. Each section also provides, for the most part, the downgrades to be applied for deviations. However, some downgrades in some of the sections are not completely specified and, as such, are described here.

a. The size of a loop or part loop is not a grading criterion. It will vary according to the flight characteristics of the aircraft. A large loop is not graded any higher or lower than a small loop, but any variation to the radius will downgrade these figures.

b. All radii are to be constant. Each visible variation in the radii in a loop or part loop is to be downgraded by one (1) point.

c. Where radii of part loops within these figures are required to be the same and they are not, a downgrade of one (1) point should be applied for each mismatch. The standard is the first part loop flown within the figure.

d. Roll elements that are to be done on lines must be centered and are to define two equal length line segments either side of the roll element. Refer to rule 7.1 for downgrades.

e. Where a roll element is to be done entering or exiting a part loop there is to be no line shown between the part loop and the roll element. The downgrade for showing a line in these situations is a minimum of two points. This criterion is not meant to imply that one element (roll or loop) must start

before the preceding element is completely finished. A brief hesitation between elements (similar to opposite rolls) should not be downgraded.

Sections 8.8.1 to 8.8.3: Not in Use.

8.8.4.1: Family 8.4.1 - 8.4.28: Humpty Bumps and Diagonal Humpty Bumps. These figures, whether vertical or performed with 45-degree lines, are judged as combination of lines and loops. However, the half loop in the middle of the figure can be of a different radius than the entry or exit radii (Fig. 46). These half loops must still have a constant radius from the time they depart the vertical or 45-degree line. This requires a change in angular velocity during the half loop.

The lines in these figures may be of different lengths, and therefore the entry and exit altitudes of these figures can be different. Rolls on any of these lines must be centered.

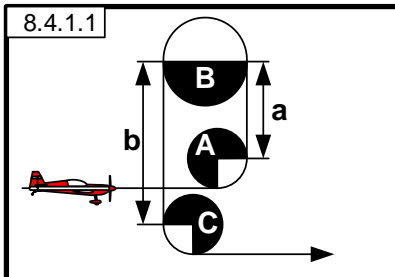

Fig. 46

Humpty Bumps: Radii A – B – C do not have to match. Lines a and b do not have to be the same length.

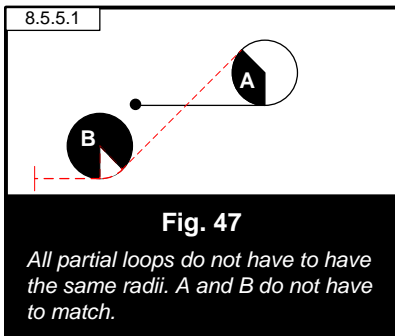

Fig. 47

All partial loops do not have to have the same radii. A and B do not have to match.

except for roll(s) following a spin. Angles drawn in the “ARESTI Aerobic Catalogue (Condensed)” (Fig. 47 and 48), are to be flown as partial loops. In the case of this figure, a 5/8 loop is flown followed by a 45-degree downline with an optional roll and then a 3/8 loop back to upright horizontal flight.

8.8.5: Family 8.5.1-8.5.24: Half Cubans and Vertical 5/8ths Loops. When the looping portion of the figure is immediately preceded or followed by a roll or rolls, there must be no visible line between the roll and loop elements. The rolls on vertical and 45-degree lines must be centered,

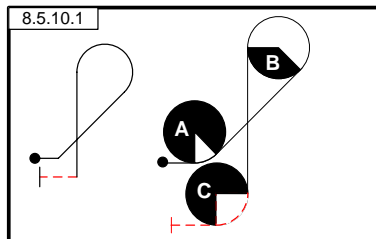
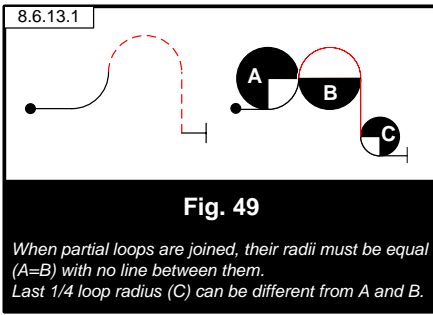

Fig. 48

Partial loops do not have to have the same radii. A – B – C do not have to match.



8.8.6: Family 8.6: “P” Loops and Reversing “P” Loops
 When $\frac{1}{4}$, $\frac{1}{2}$ or $\frac{3}{4}$ loops join each other in these sub-families, the radii must be equal and there is no line between the loops. Inserting a line between joined loop segments requires a minimum two (2) point deduction depending on the length of the line (Fig. 49).

Roll elements on the vertical line must be centered.

Roll elements at the apex of the loop must be centered in the loop and flown on the arc of the loop. Flying the roll on a line at the apex of the loop is at least a two (2) point downgrade. If the roll is not centered, it must be downgraded 0.5 points for every five degrees that it is off center.

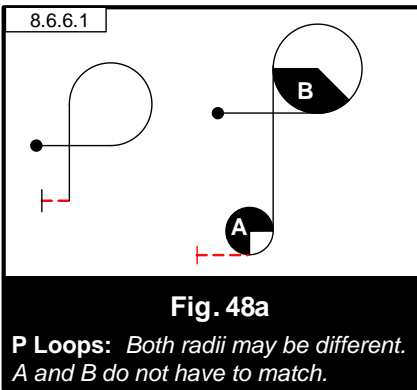

When a loop portion is preceded or followed by a roll element, there must be no visible line between the roll element and the loop portion. Inserting a line between the roll element and loop portion requires a minimum downgrade of 2 points.

The $\frac{1}{4}$ loop to or from horizontal flight should have a reasonable radius, but need not match the other looping radii (fig.48a).

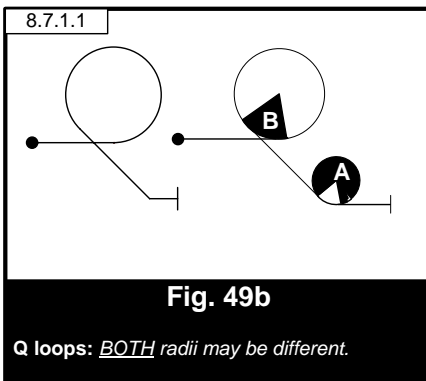

8.8.7: Family 8.7: $\frac{7}{8}$ th Loops. Sometimes called “Q Loops,” these figures consist of a $\frac{7}{8}$ th loop with either a 45 degree entry or exit line. The $\frac{1}{8}$ th loop to or from the 45 degree line should have a reasonable radius, but need not match the radius of the $\frac{7}{8}$ th loop. (fig.49b)

Roll elements on the 45 degree line must be centered. Roll elements at the apex of the $\frac{7}{8}$ th loop must be centered on the loop

and flown in the arc of the loop. Flying the roll on a line at the apex of the loop is at least a two (2) point downgrade. If the roll is not centered, it must be downgraded 0.5 points for every five degrees that it is off center.

When the 7/8th loop is preceded or followed by a roll element, there must be no visible line between the roll element and the loop. Inserting a line between the roll element and 7/8th loop requires a minimum downgrade of 2 points.

Note: for certain types of “Q” Loops in this family, rolls are not allowed at the apex of the 7/8th loop (for example, figures 8.7.x.3 and 8.7.x.4).

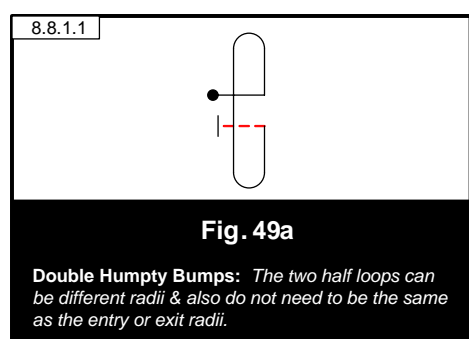

8.8.8: Family 8.8: Double Humpty Bumps. These figures are generally judged using the same criteria as Single Humpty Bumps. (See section 8.8.4.1) The two half-loops are not required to match each other, nor are they required to match either the entry/exit loop radii. As with Single Humpty Bumps, the entry and exit altitudes need not be equal (Fig.49a).

8.8.9: Not in Use.

8.8.10: Family 8.10: Reversing 1 ¼ Loops. The ¾ and ½ loops in these sub-families must be the same size and are flown as continuous segments with no line between the loops. Inserting a line between joined loop segments requires a minimum two (2) point deduction depending on the length of the line.

Roll elements on the vertical line must be centered.

When the ¾ loop is preceded by a roll element, there must be no visible line between the roll element and the loop portion. Inserting a line between the roll element and loop portion requires a minimum downgrade of 2 points.

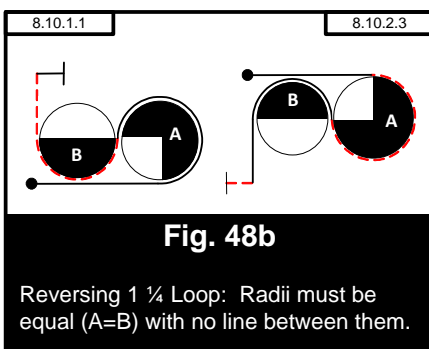

The final ¼ loop to horizontal flight should have a reasonable radius, but need not match the other looping radii.

8.9: Family 9: Rotational Elements. Rolls (9.1 - 9.10) may be performed on horizontal, 45-degree or 90-degree lines, on complete loops, between part-loops, between part-loops and line, and following spin elements.

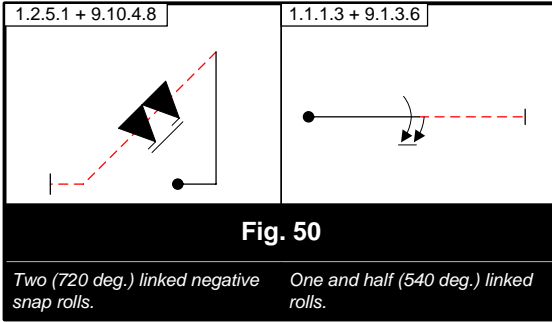

They may be ¼, ½, ¾, or a full 360 degrees in their rotation, up to two consecutive full rolls. Additionally, rolls may be flown in combination with turns as prescribed in Family 2 (Rolling Turns). In all cases, the same criteria apply: the rate of roll must be constant

throughout the roll(s). The aircraft should continue to project, during the rolling portion, the prescribed plane and direction of flight.

Multiple rolls may be linked, unlinked or opposite:

a: When rolls are in continuous rotation, the tip of the symbols are linked by a small line. When flying linked rolls there is no pause between them, (Fig. 50).

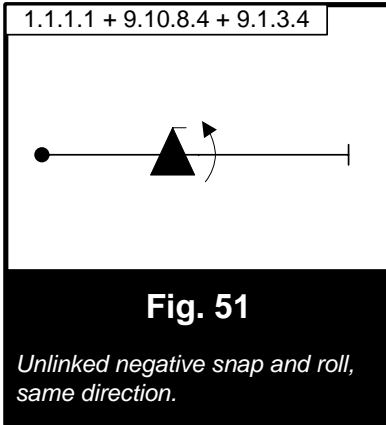

Should there be one; the figure should then be zeroed.

b: Unlinked rolls must be of different types, the two types being defined as follows:

Type I: Aileron rolls (rolls and point rolls)

Type II: Snap rolls (positive and negative) – also referred to as

“Flick Rolls”

No line links the symbols, though their tips are drawn pointing in the same direction (i.e. on the same side of the line). Unlinked rolling elements must show a brief but perceptible pause between the elements that comprise the rolling combination. Absence of a perceptible pause between elements of the combination shall be downgraded by 1 point. This downgrade applies if the direction of rotation is required to be the same or opposite. (Fig. 51)

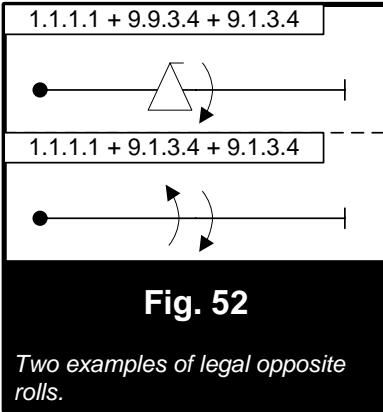

c: Opposite rolls may be either of the same or different type. In opposite rolls, the tips of the symbols are drawn on opposite sides of the line, indicating they are to be flown in opposite directions of rotation. The pilot may elect to fly the first roll in either direction, but the second roll must be the opposite direction to the first. Opposite rolls, including those in rolling turns, should be flown as one continuous maneuver - the brief pause between opposite rotations should be minimal (Fig. 52). If the two rolls are of

the same type, they must be flown in opposite direction if they are not linked.

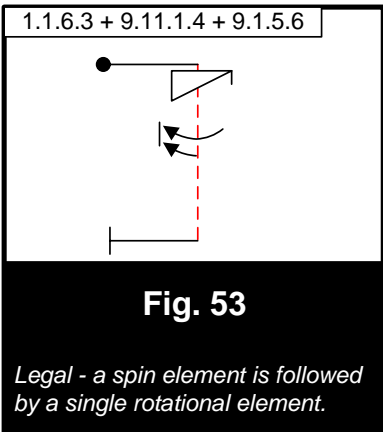

d: Either aileron rolls or snap rolls may follow spin elements (Family 9.11 or 9.12). A spin and a roll combined on the same vertical downline will always be unlinked. They may be flown either in the same or opposite direction, as shown by the position of the tips of the symbols on the ARESTI diagram. The spin will always be the first element with a maximum of two (2) turns. It can be followed by a second rotational element like a roll or a snap roll also limited to a maximum of two (2) turns (Fig. 53).

Adding a third rotational element will make the maneuver illegal, i.e. a one turn spin combined with one opposite roll and one opposite half roll (Fig. 54).

8.9.1: Family 9.1: Rolls.

The penalty for varying the rate of roll is one (1) point per variation. Any stoppage in the roll that could result its being considered a point roll would zero (0) the figure.

The finish of the roll must be as crisp and precise as possible.

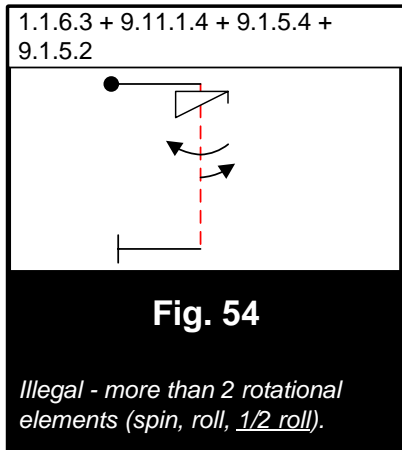

Coming to a slow finish in fact represents a change in the rate of roll and should be penalized accordingly.

The wing must stop precisely after the desired degree of rotation and not go past the stop point and then return. This is referred to as “bumping the point” and a deduction of 0.5 points per 5 degrees shall be given in this case.

8.9.2: Family 9.2 - 9.8: Point Rolls. These rolls are judged on the same criteria as the standard roll, only the aircraft stops rotation during the roll for a pre-stated number of times, i.e. 2, 4, or 8. The rate of the roll and the rhythm of the points must be constant throughout with the aircraft projecting the pre-stated plane and direction of flight.

The pauses will be of identical duration and the degree of rotation between each pause shall be 180 degrees, 90 degrees, or 45 degrees, as depicted by the Aresti diagram. Each visible variation in the duration of the pause segments is downgraded by one (1) point. Errors in degrees of rotation (under / over rotating the points) are downgraded at a half (.5) point per five (5) degrees.

The roll rate of the rolling segments must be constant with each roll segment matching that of the preceding segment. Any visible deviation in roll rate from one segment to the next, or within a segment, is to be downgraded by one (1) point per occurrence.

The duration of the rolling segments as compared to the pause segments need not be equal. Each pause of a point roll must be clearly recognizable in every case. If a pause is not recognizable or is omitted, the figure is graded a zero (0).

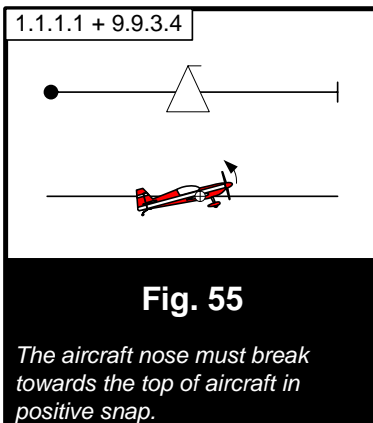

8.9.3: Family 9.9: Snap Rolls (“Flick Rolls”). Snap rolls may be positive (pitch to the canopy) or negative (pitch to the wheels). Other than this difference, all judging criteria are the same for either type of snap.

Snap rolls are difficult to judge due to the speed of the snaps and the variation in the manner in which different aircraft perform snaps. However, two things must be present in order that a judge can decide that a snap roll has occurred. They are:

The nose must pitch in the correct direction as indicated by the ARESTI figure (Fig. 55 & 56).
Autorotation must be initiated.

Given the high energy nature of the snap, it is very difficult to tell if these two items are occurring simultaneously or sequentially. Therefore, there is no requirement that these two movements start simultaneously. They may occur simultaneously or sequentially in the order presented.

The requirements and downgrades that apply to snap roll elements are:

a. The snap must be done in the correct direction, positive or negative. If done in the wrong direction the maneuver is to be zeroed. Judges must watch very carefully for this as, due to the speed of the snap, it is very possible to miss an incorrect direction of the pitch.

b. There must be departure in the pitch axis in the required direction of the snap. Without some displacement in pitch there can be no high speed stall and therefore, there can be no snap. Aerobatic aircraft with very high rates of roll can occasionally fool a judge and present an aileron roll in place of a true snap. The movement of the aircraft's nose in pitch departing the flight path is a necessary clue to the proper execution of snap rolls. As always, the competitor is given the benefit of the doubt, but if a judge is certain that a proper snap roll has not been executed, a zero (0) is to be given.

c. Autorotation must be initiated either simultaneously with the pitch departure, or immediately subsequent to it. No downgrade is to be applied if these two motions occur sequentially in the order just stated. Autorotation is difficult to discern but a definite clue is that there will be a yaw component to the rotation. Lacking any visible yaw, the aircraft will be rotating only on its roll axis and not presenting a true snap. As always, the competitor is given the benefit of the doubt, but if a judge is certain that autorotation is not present and therefore that a proper snap roll has not been executed, a zero (0) is to be given.

d. Any rotation / roll observed prior to the required pitch movement is to be downgraded 0 .5 points for each 5 degrees of such rotation.

e. In the event that the start of autorotation is delayed somewhat after the required pitch movement has been shown, it is possible that the aircraft will draw a visible line between the pitch and the start of autorotation. If this occurs, the maneuver should be zeroed (0).

f. Autorotation, once initiated, must be maintained to the prescribed finish point of the snap roll. Coming out of autorotation early and

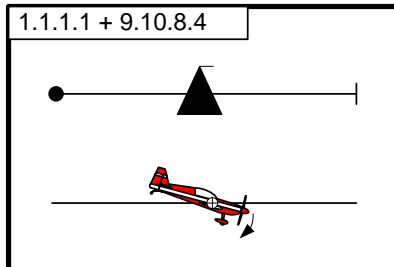

Fig. 56

The aircraft nose must break flight path away from the top of aircraft in negative snap.

aileroning to the end of the snap is a common error. In this case, a downgrade of 0.5 points for each 5 degrees is to be applied for the amount of rotation remaining at the point the autorotation ends, i.e., for however much the pilot ailerons to the finish. If the autorotation ends with more than 90 degrees of rotation remaining, even if the roll is completed with aileron, the snap roll is to be zeroed.

g. Alignment during the snap will vary from the prescribed line of flight due to the yaw displacement that is characteristic of a proper snap. This variation may be very small. However, immediately on completion of autorotation, the aircraft must be realigned with the prescribed line of flight. This will put the aircraft on a parallel but offset line or arc from that being flown prior to entry to the snap. If the aircraft exit from the snap is a line or arc that is identical to the entry line this is a clue that a proper snap was not executed. Again, the offset of the snap exit line or arc from snap entry line or arc may be very small but should be there. No penalty is to be applied for the offset or the realignment of the aircraft immediately after autorotation is completed. Lacking that realignment the extension of the snap exit line will be misaligned and that should be downgraded at 0.5 for each 5 degrees of misalignment from the prescribed line of flight in pitch, roll and yaw. "Line of flight" as just used here includes arcs.

8.9.5: Family 9.11 - 9.12: Spins.

Spins may be positive (entered from upright flight) or negative (entered from inverted flight). Other than this difference all judging criteria are the same for either type of spin.

Spin elements may be included in a number of Family 1 and Family 8 figures (where so indicated by the optional spin symbol in the ARESTI catalog). All spins begin from horizontal flight with a defined entry line. This entry line to the spin is to be judged and downgraded as required in the same manner as any other wind corrected horizontal line. The only exception to judging the entry line is if the spin entry line is also the entry to the sequence. In this instance,

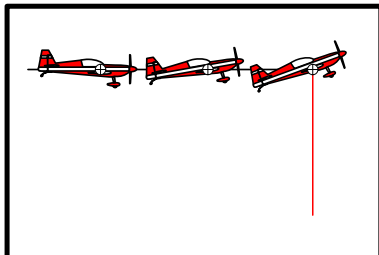

Fig. 57

The horizontal flight path should be maintained until the spin starts.

the entry line is not judged and judging begins at the spin stall break. It should be noted that the flight path of the spin entry line should remain constant and not be influenced by the change of pitch attitude required to achieve the stall (Fig. 57), i.e., judge the track.

When the aircraft stalls, the nose will fall and at the same time a wing tip will drop in the direction of the spin initiating autorotation. The fall of

the nose and the drop of the wing are to occur simultaneously. Failure to achieve this is to be considered a “late entry” and is to be downgraded. After completion of the prescribed number of turns, the aircraft must stop rotating precisely on the prescribed heading and then a wind corrected vertical down line must be shown. If a roll element follows a spin, there should be a brief, but perceptible pause (similar to unlinked rolls) between the spin and the roll. Because there is no vertical line before the spin, there is no criterion to center a roll element that follows the spin on the vertical down line. No account is to be taken of the pitch attitude of the aircraft during autorotation, as some aircraft spin in a nearly vertical pitch attitude while others may spin in a somewhat flat attitude. Given these varying attitudes some aircraft may require a visible downward movement in order to set the aircraft into position to fly the required vertical downline after completion of autorotation. No downgrade is to be applied for this downward nose movement. Also, the speed of autorotation is not a judging criterion.

The requirements and downgrades that apply to spin elements are:

a. The entry line to the spin is a wind corrected line and any deviation in pitch, roll or yaw is to be downgraded at 0.5 points per each 5 degrees of misalignment. However, be sure to judge the track and not the attitude.

b. At the point of stall, the wings are to be level and any deviation in roll will be downgraded at 0.5 points for each 5 degrees of deviation. However, at this point in the spin element, when the aircraft is stalled or near stalled, no penalty should be applied for deviation in yaw due to wind. Also, due to wind the yaw attitude of the aircraft relative to the prescribed degree of rotation may result in actually rotating more or less than prescribed (Fig. 58). No penalty is to be applied for this variation provided it results from the effect of wind on the spin entry.

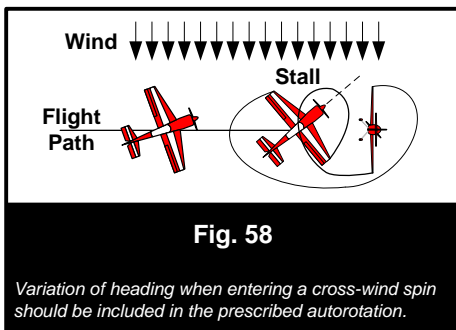

c. There must be a stall in order to have a proper spin. As always, the competitor is given the benefit of the doubt, but if a judge is certain that no stall occurred, a zero (0) is to be given.

d. The stall and the wing drop that indicates the start of auto rotation are to occur simultaneously. If they do not occur simultaneously, a downgrade of 0.5 points for each 5 degrees of movement that occurs in one movement before the other movement is shown, e.g., if the nose drops 20 degrees before the wing drop is shown a 2 point penalty is applied.

e. Starting the spin rotation in the wrong direction of rotation with a subsequent correction that forces the aircraft into the proper direction of rotation is to be penalized. Rotation movement in the incorrect direction is to be downgraded at .5 point for each 5 degrees of incorrect rotation.

f. The rotation in a spin must be autorotation which can be difficult to discern. A clue to making the judgment on "autorotation or not" is that autorotation will have a visible yaw component to the rotation. Absent this yaw component, it is probable that the aircraft is in some kind of an aileron roll. If a judge is certain that no autorotation occurred, a zero (0) is to be given.

g. The spin element must complete precisely at the degree of rotation called for by the ARESTI and not be short or beyond the prescribed end point of the rotation. Any deviation is to be downgraded 0.5 points per 5 degrees that the aircraft completes the spin short or long of the prescribed stopping point. Note that autorotation must carry to completion. It is common to see a pilot come out of autorotation early and aileron to the finish of the spin. If this occurs a penalty of 0.5 points per 5 degrees is to be applied for the amount of "aileroning" used to complete the required rotation.

h. Upon completion of the prescribed degree of rotation a vertical down line is to be shown. Omission of this line is to be downgraded one (1) point. Note that roll or snap elements may be called for on this down line after a spin. If they are called for, no centering requirement applies to the placement of these elements on this down line.

